

Reactor Physics: Design Parameters for GFRs

22.39 Elements of Reactor Design, Operations, and Safety

Fall 2006

Chris Handwerk

Massachusetts Institute of Technology

Outline

- Background
- Design Philosophy
- Traditional breeder designs and traditional safety concerns
- Reactor physics design in relation to Gen IV goals
 - Sustainability/Proliferation Resistance
 - Economy
 - Safety
 - ◆ Self-controllability

Portions of this presentation are derived from the Fall 2005 version by Dr. Pavel Hejzlar

Why the renewed interest in GFRs?

- Extensive work done in 1970's
- Carter administration ban on reprocessing
- Generation IV International Forum
 - Safety
 - Non-proliferation
 - Economics
 - Sustainability
 - ◆ Resources
 - ◆ Waste
- 6 Candidate Designs
 - **GFR**
 - VHTR
 - SCWR
 - SFR
 - LFR
 - MSR

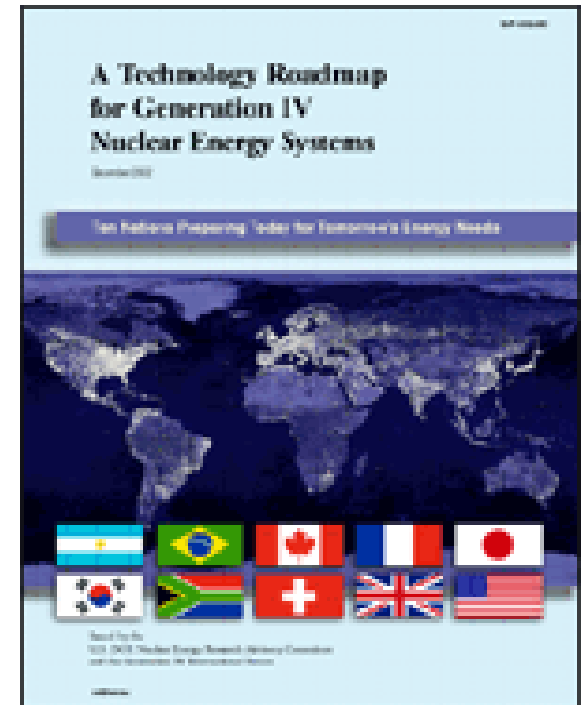

Reactor physics and Gen IV goals

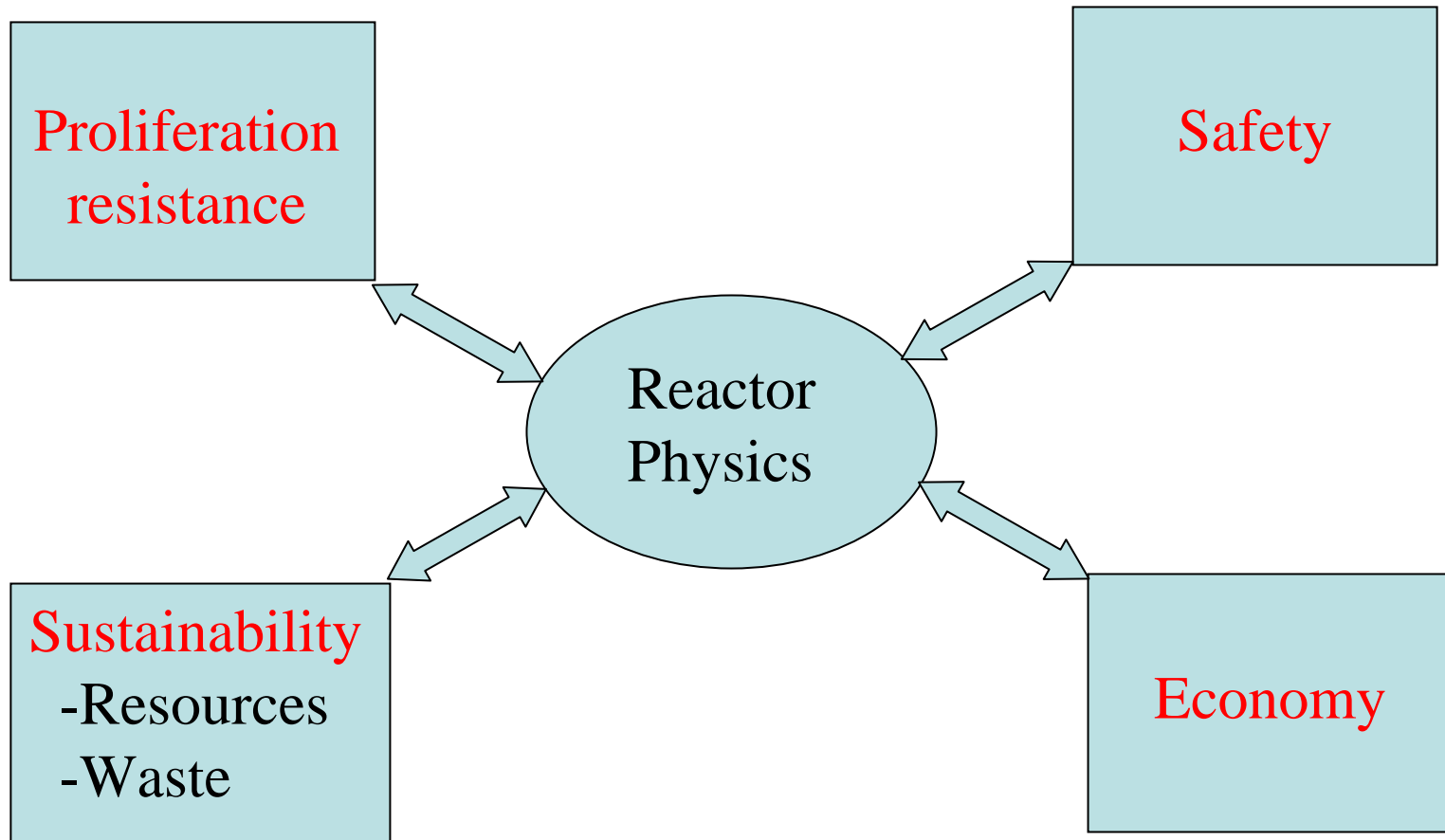

The Engineering Pinwheel

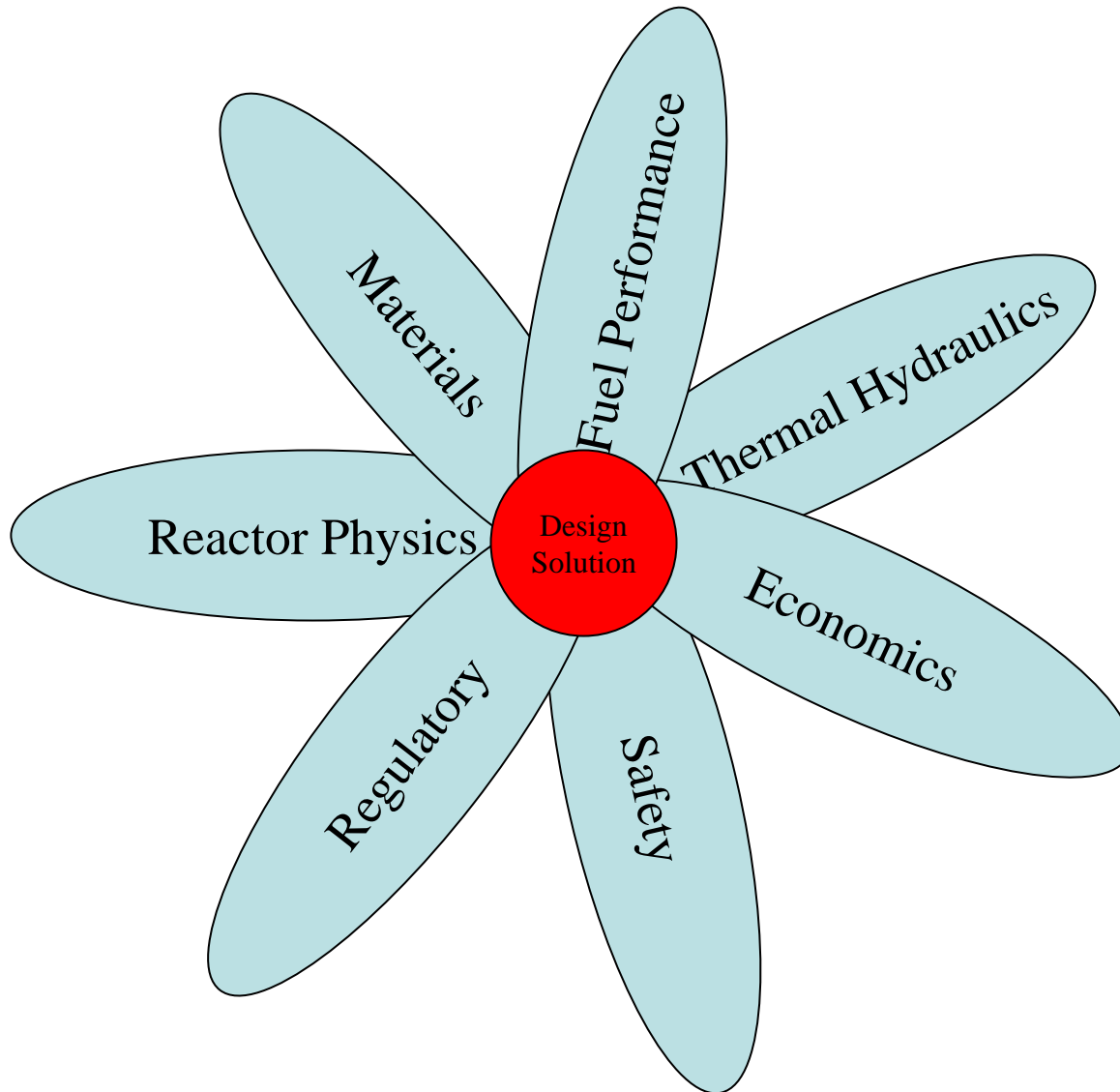

Fast Reactor Fundamentals

- The neutrons are fast
- No moderator (most of the time)
- Coolant is non-moderating
 - Liquid metal
 - Gas
- Neutronic behavior governed mostly by Pu and TRU
 - Much lower β than LWRs (0.0035 v. 0.0065)
- Shorter prompt neutron lifetime
- Tighter lattice than LWRs
- A LOCA will insert positive reactivity
- MTC not the chief reactivity coefficient of concern as in LWRs

Steady State Reactor Physics Parameters

Parameter	Design Philosophy
Power Peaking <ul style="list-style-type: none"> ■ Intra-assembly, i.e. pin-to-pin ■ Radial ■ Axial 	Provide sufficient margin to thermal hydraulic limits
Reactivity limited lifetime	Achieve burnups such that the design (1) is cost competitive and (2) has fluence that is not excessive when compared to other options
Isotopic Composition	Minimize the volume and radiotoxicity of spent fuel while providing enough Actinide inventory to act as fuel for current and future cycles
Active Reactivity Control <ul style="list-style-type: none"> ■ Reactivity Swing ■ Control Rod Worth 	Keep the reactivity swing low enough such that control rod worth does not become excessive (i.e. significantly beyond current experience, within rod ejection and stuck rod limits)

Steady State T/H Parameters

Parameter	Design Philosophy
Peak Centerline Temperature	<ul style="list-style-type: none">■ Fuel melting■ Fission gas release■ Doppler
Peak Cladding Temperature	<p>Mechanical properties/ integrity of cladding</p> <ul style="list-style-type: none">◆ Creep◆ Stress/Strain
Pressure Drop	<ul style="list-style-type: none">■ Circulator Work■ Natural Circulation/DHR

The Relation between Rx Physics and T/H Design Constraints

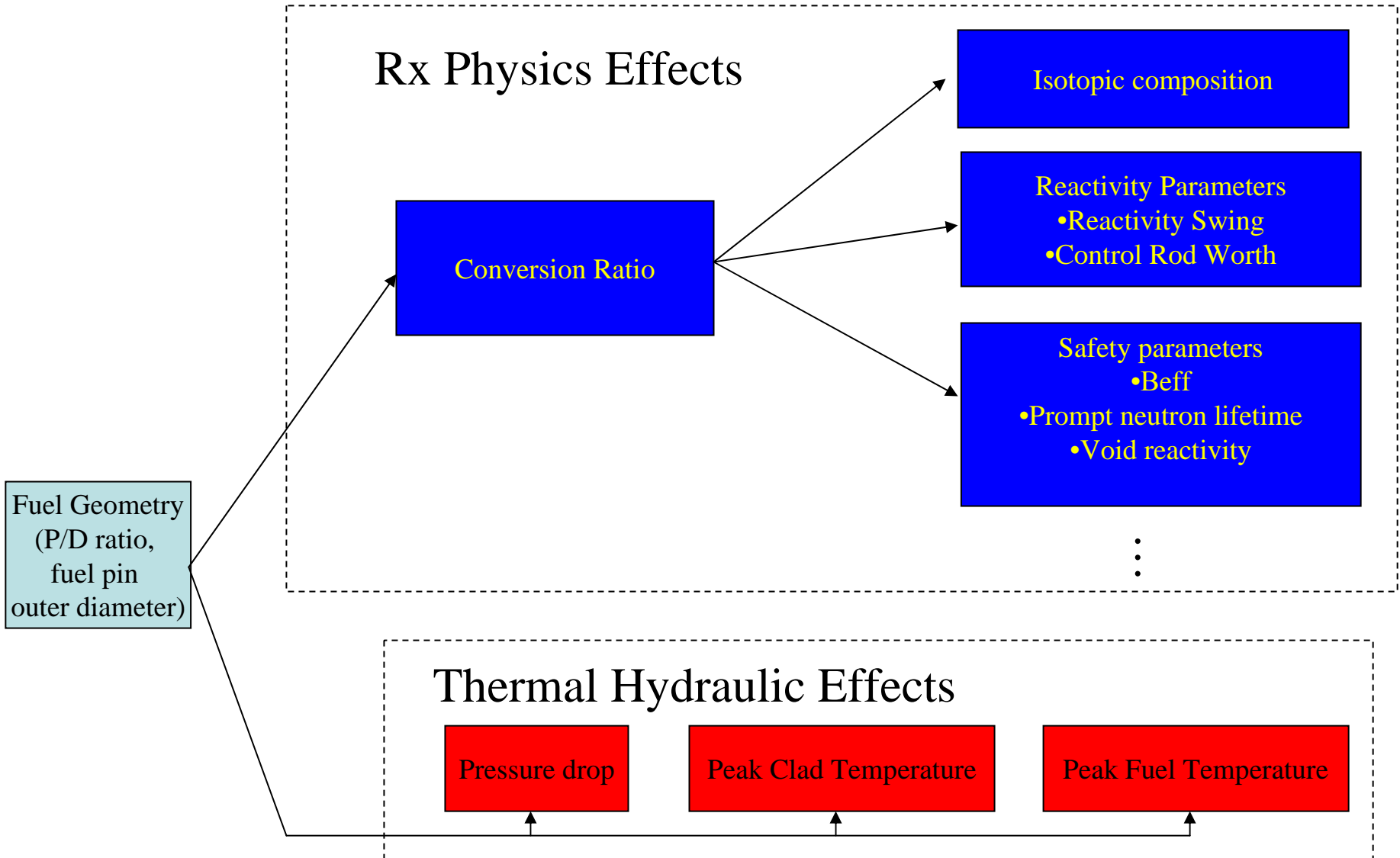

Selection of a coolant

- Chemical compatibility
- Neutronic properties
- Thermal Properties
 - Boiling/Melting Point
 - Heat removal capability
 - ◆ High thermal conductivity
 - ◆ Large heat capacity
- Density
 - Natural Circulation capability
 - Required Pumping Power
- Availability/cost
- Other....

Coolant Case Study: S-CO₂

- Power Conversion System (PCS) work begat the neutronics work
 - High efficiency Brayton cycle (45-50%) v. Rankine (33%)
 - Allows for a direct cycle
- Can provide better natural circulation capability than He
- Can do it all at lower temperatures (650°C) than Helium (850°C)
- Requires a higher pressure for Decay Heat Removal and cycle efficiency (20 MPa v. 8 MPa)
 - What integrated engineering design challenges does this pose?

Traditional sodium FBR designs

- Large power rating (~3000MWt)
- Very high power density (~300kW/l)
 - To reduce fuel cycle cost
 - To minimize doubling time
- Short doubling time (~25 years)
- Oxide fuels - UO₂-PuO₂ driver fuel, use of UO₂ blankets
- Breeding ratio >1 (1.25)
- Pool type reactor
- Active safety
- Intermediate loops
- Rankine cycle
- Difficult maintenance (opaque coolant)
- Complex and expensive

Diagram of reactor removed due to copyright restrictions.

Traditional reactor physics (safety) concerns for early liquid metal cooled FBRs

- Small effective delayed neutron fraction
 - Small value of dollar unit for reactivity, hence concern that prompt critical state can be easier to reach
- Short prompt neutron lifetime
 - Concern over extremely rapid power rise if reactivity increase exceeds prompt critical value
- Hypothetical core disruptive accidents
 - Core geometry not in most reactive configuration
 - Loss of core geometry may hypothetically lead to reactivity increase and large energy generation
 - Although of extremely low probability, these scenarios received substantial attention
- Reactivity insertion $> \beta$ from coolant voiding
 - Local voiding is also a concern
- External blankets required for breeding

Gen IV Goals 1 & 2: Sustainability/Proliferation Resistance

- **Traditionally** – high utilization of resources (motivated early development of fast reactors with high breeding ratio - blankets)
- Emphases in Gen IV
 - High resource utilization
 - **Waste minimization**
 - **Proliferation resistance** } new
- To **reduce waste long-term radiotoxicity** to that of natural U in <1000yrs – full recycling of TRU (including MA) with losses <0.1% needed
- Enhanced **proliferation resistance** favors elimination of depleted U blankets, avoidance of Pu separation and maintenance of dirty plutonium isotopics throughout the cycle

Impact of recycling TRUs

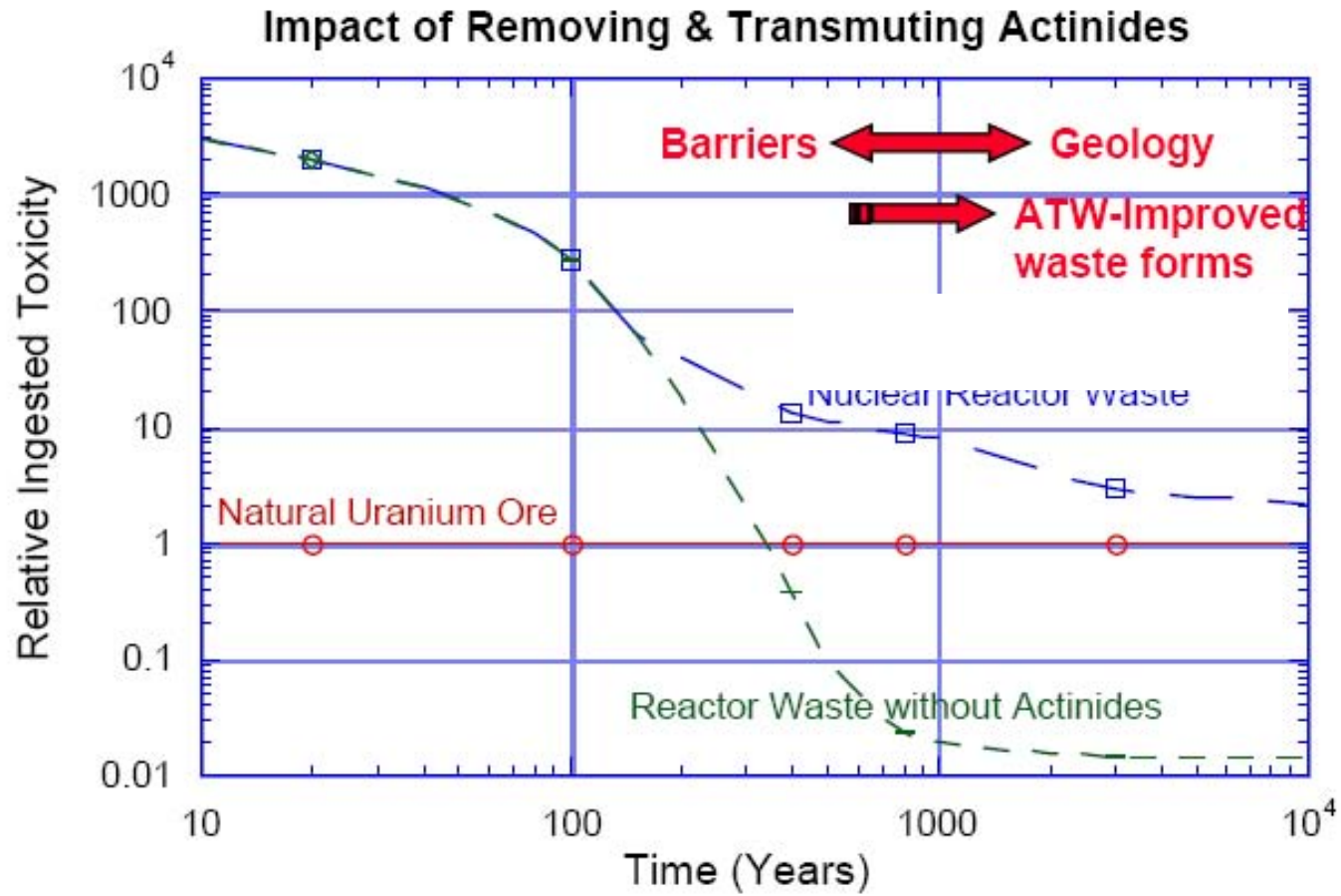

Sustainability-driven design choices

GFR for both waste management and resource utilization

- Use accumulated TRU from spent LWR for 1st FR core
- Design **GFR with BR=1**, no blankets to avoid clean Pu
- Recycle TRU without Pu separation, Depleted U feed
- If enough GFRs deployed, LWR legacy TRU inventory eliminated
- After full transition to GFR, enrichment could be eliminated

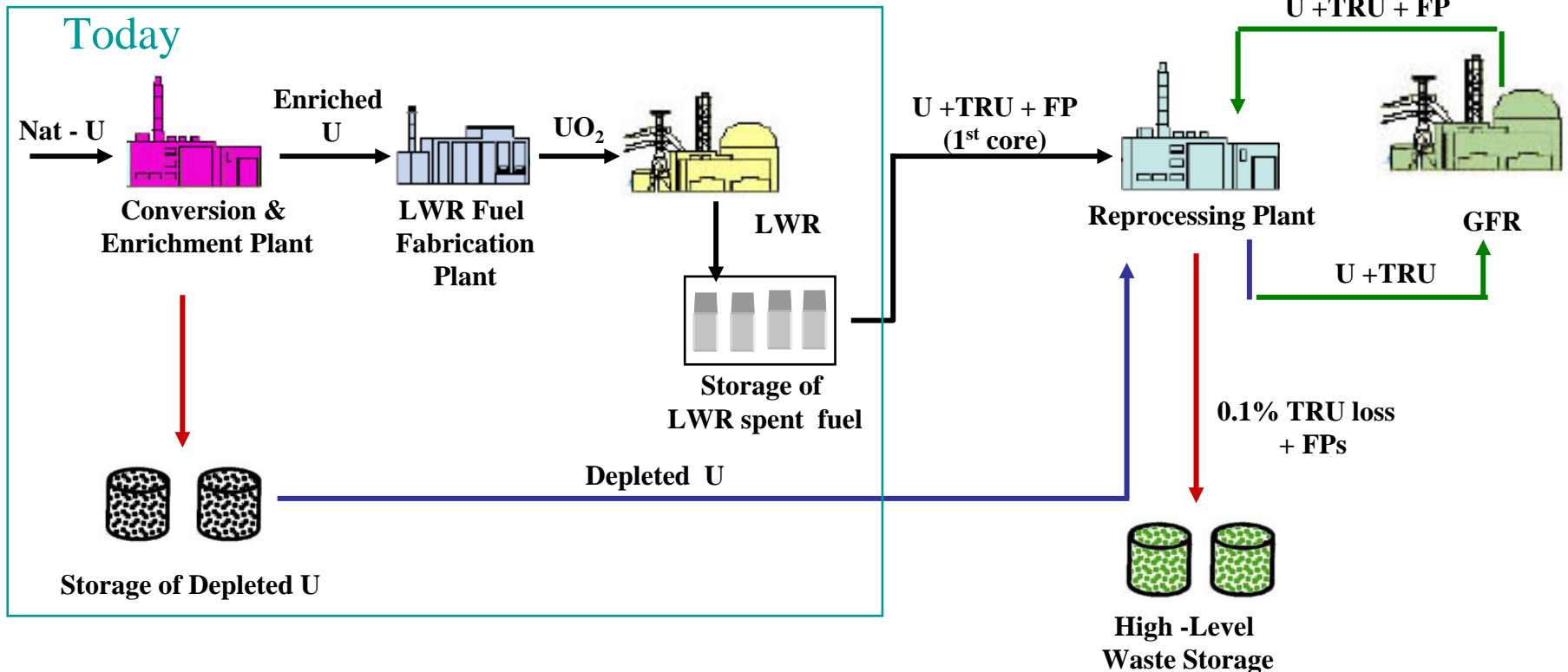

Consequences of sustainability-driven choices

- **Small effective delayed neutron fraction**
 - TRUs have small β
 - TRUs in LWR spent fuel
49%Pu239, 23%Pu240,
7%Pu241, 6.6%Np237,
5%Pu242, 4.7%Am241,
2.7%Pu238
 - Smaller margin to superprompt criticality, hence reactor control more challenging
 - What can be done to increase β_{eff} ?
 - ◆ Not much
 - ◆ Harden spectrum to fission more U238, but this worsens coolant void worth
 - ◆ Increase leakage, but this hurts neutron economy

Graph removed due to copyright restrictions.

Consequences of sustainability-driven choices (Cont')

- **Increased positive coolant void worth**
 - Safety issue
 - Typically much smaller in GFR than in LMRs
 - Can be fast
 - Smaller β makes coolant void worth larger in terms of reactivity in dollars
 - More positive coolant void worth is due to **TRU loading** (primarily Pu239, Np237 and Am241)
 - Why?

Neutron spectrum in GFR

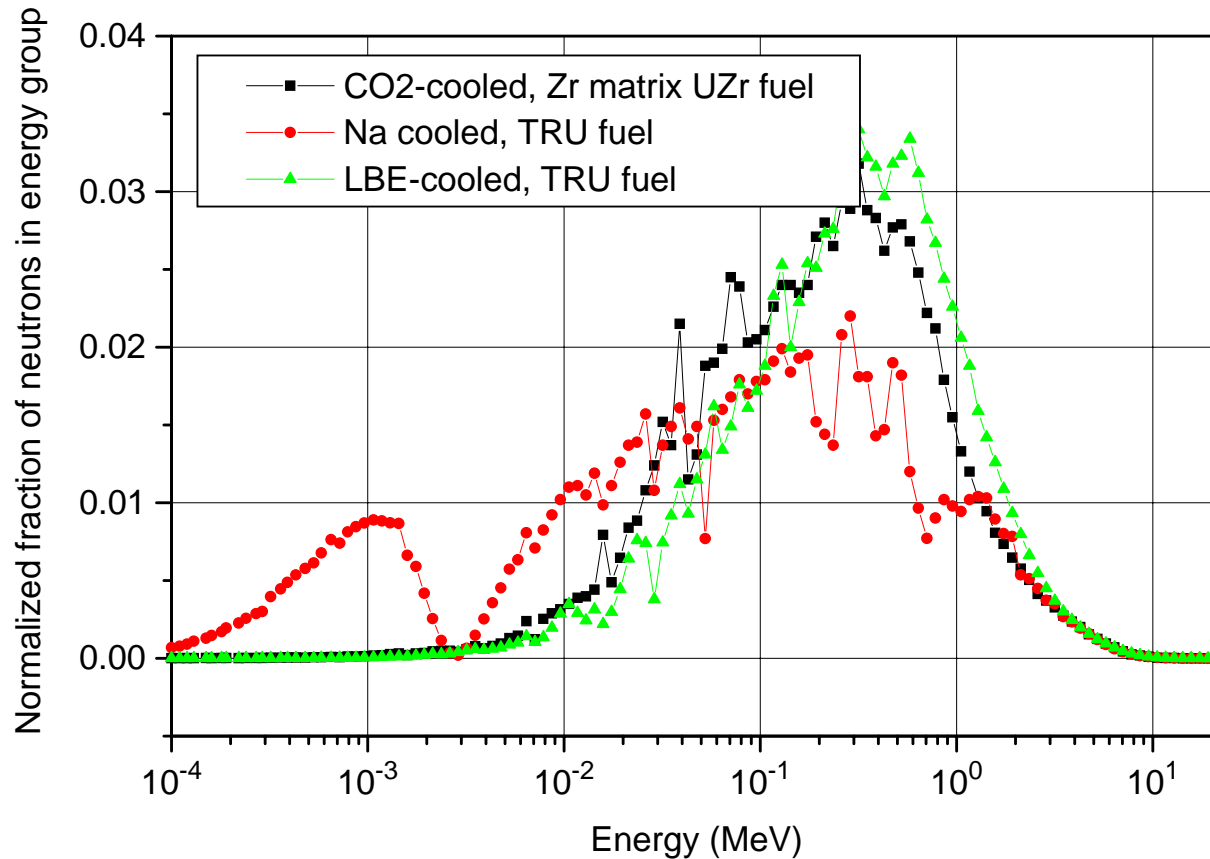

Positive coolant void worth in FRs

Three components of coolant void worth

1. Spectrum hardening

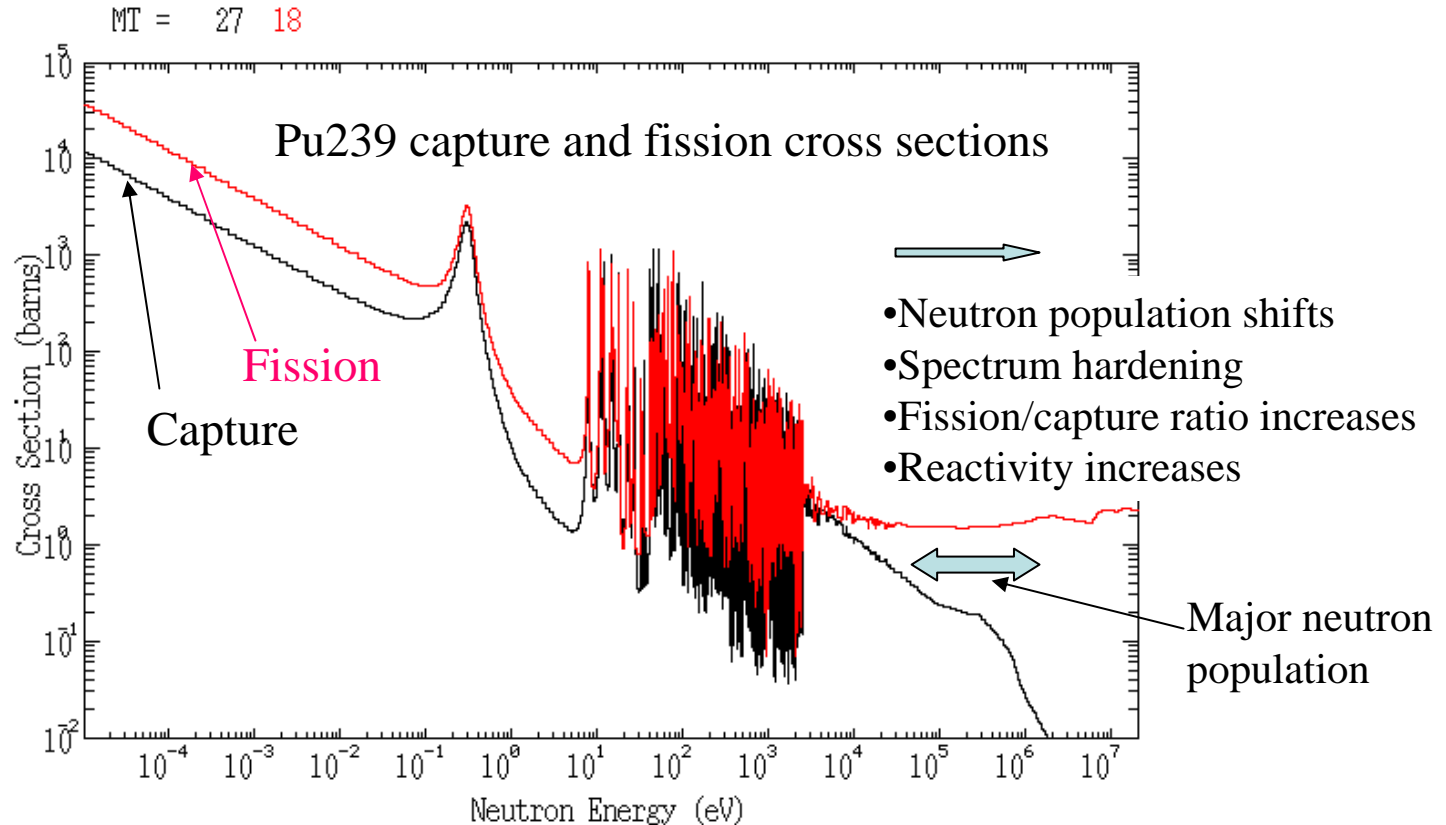

Positive coolant void worth in FRs

- This differs from U235, hence much lower void worth for U235 fueled core

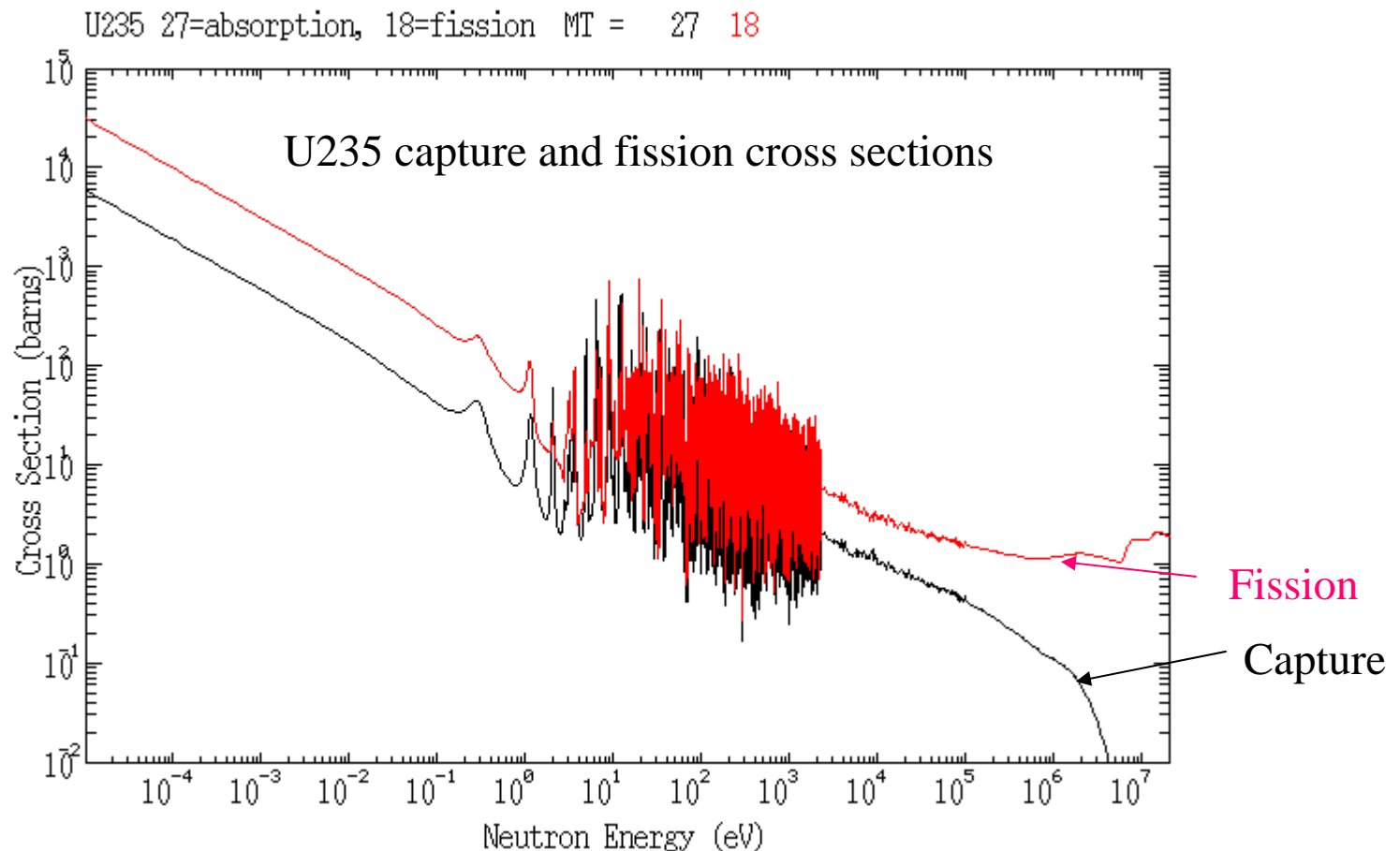

Positive coolant void worth in FRs

Minor actinides (mainly Np237 and Am241) exacerbate the problem

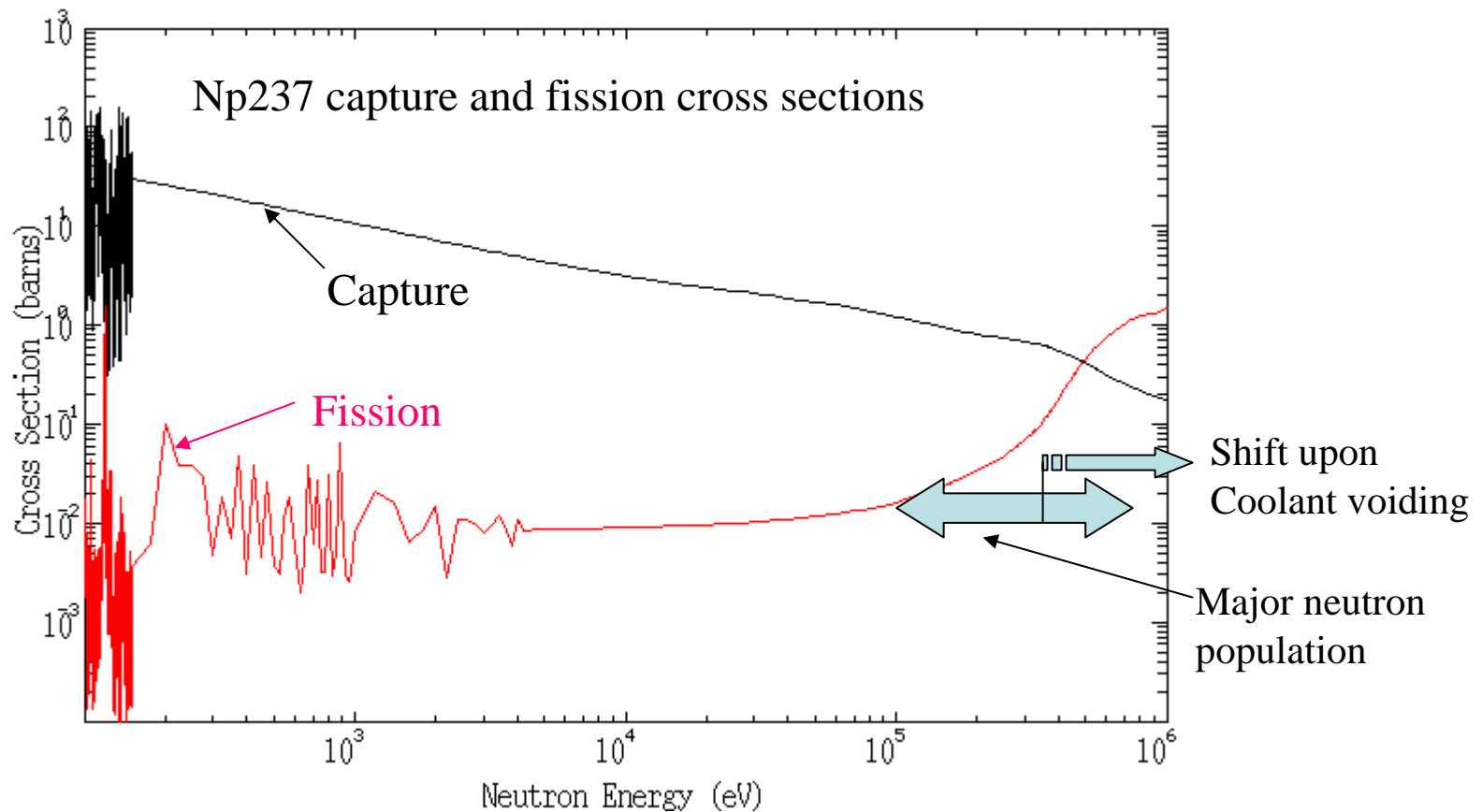

- Am 241 same behavior
- What about U238? Also an issue but σ_f comes up after 1MeV and only to 0.5barn

Positive coolant void worth in FRs (cont)

2. Coolant absorption

- Less coolant → smaller parasitic absorption, hence reactivity increases (same for over-moderated LWRs)
- Small for GFR but can be significant for LMRs – coolants with higher absorption cross section worse

3. Neutron leakage

- Less coolant → increased neutron leakage, hence reduced reactivity
- Smaller or pancake cores have lower coolant void worth
- Coolants with larger scattering cross section have larger reactivity reduction from leakage

Ways to reduce CVW in GFRs

- Although CVW is small (in comparison to LMRs), its reduction is **difficult**. Why?
- Leakage component is very small (negligible for some gases, such as He)
- Possibilities:
 1. Use core and reflector materials that exhibit an increase in absorption cross section/reduction in reflection upon spectrum hardening
 2. Use gas that has high scattering macroscopic cross section to increase benefit of leakage effect
 3. Minimize coolant fraction in the core
 4. Soften the spectrum

1. CVW solution: Titanium reflector

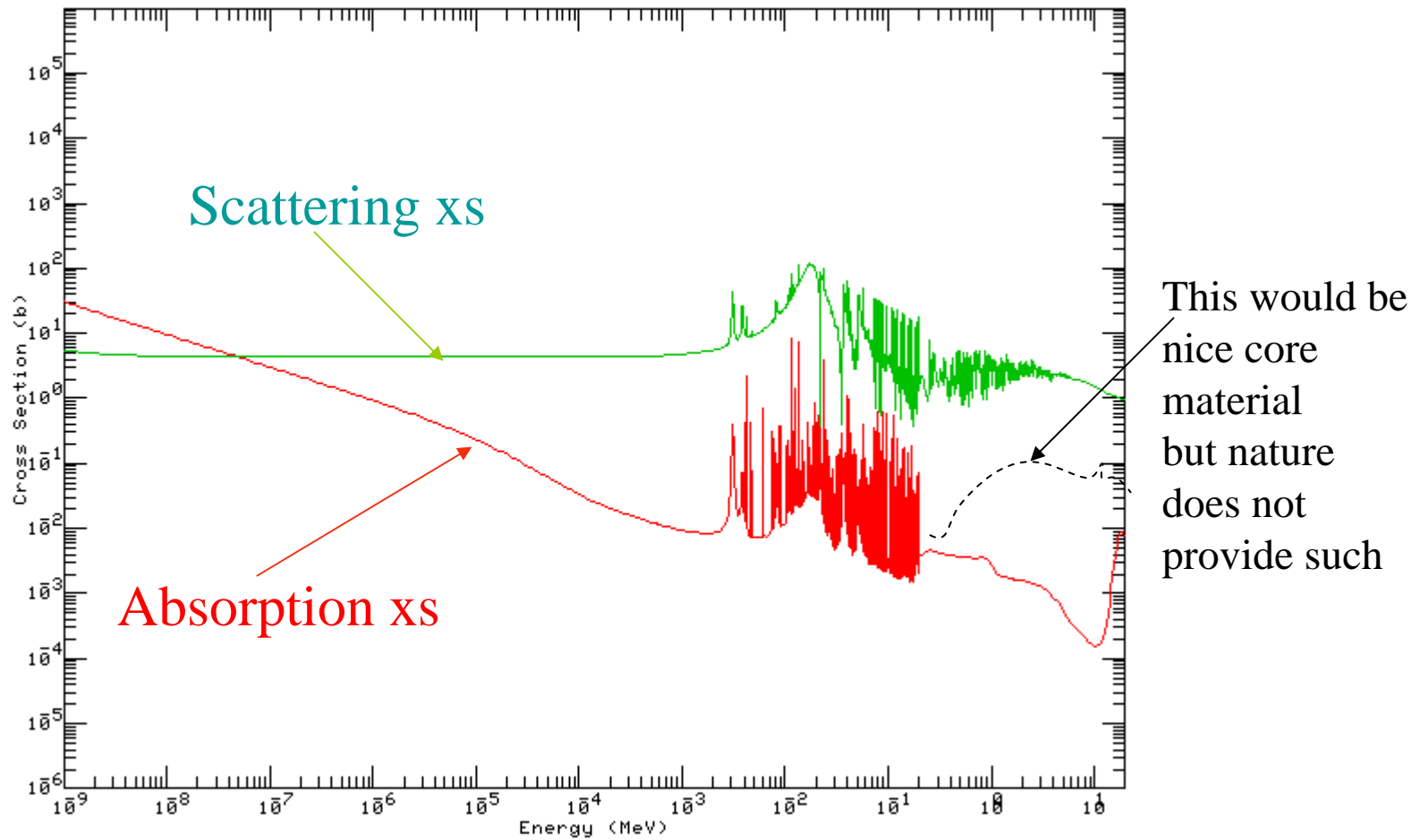

Ti capture and scattering cross sections

2. CVW Solution: Leakage effect for He and S-CO₂

Coolant void reactivity for (U-TRU)C pin fuel with Ti cladding and Ti reflector

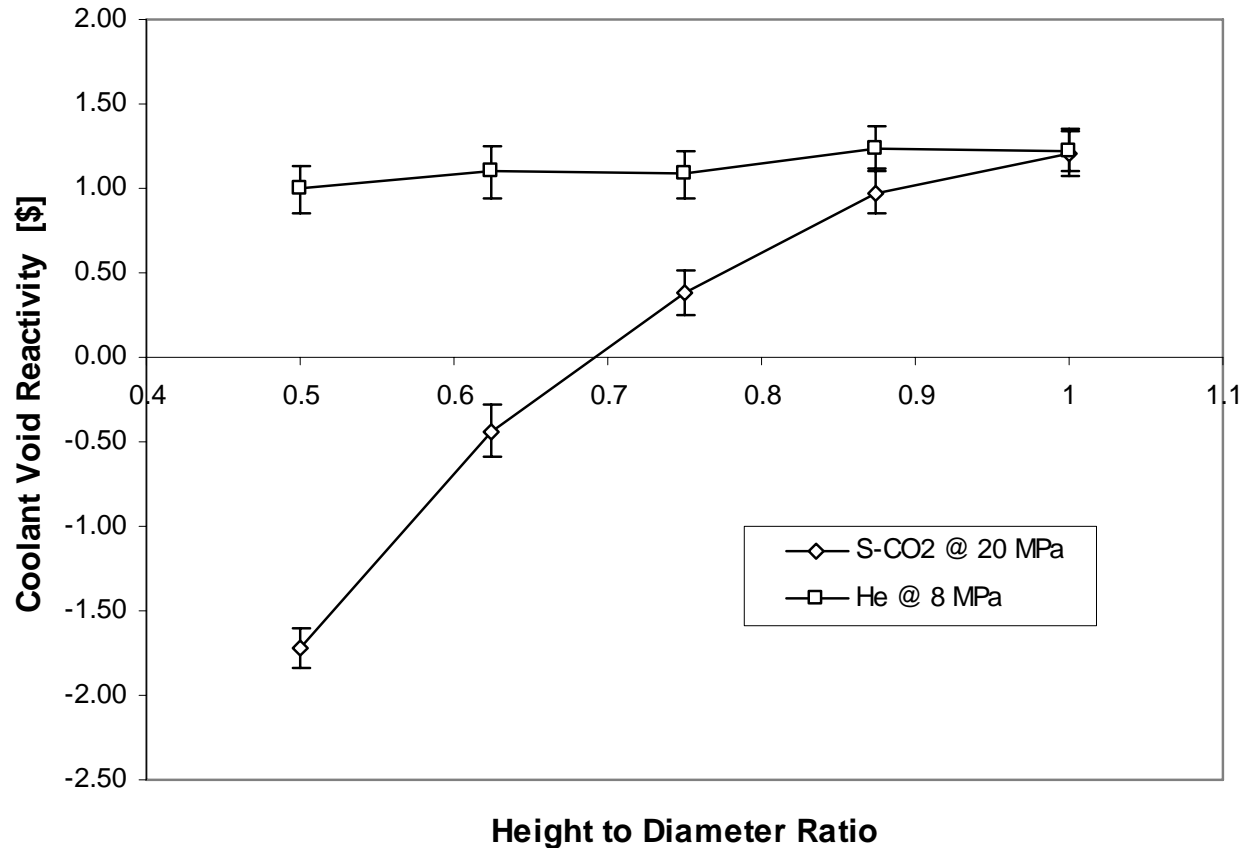

3. CVW solution: Tube-In-Duct (TID) Fuel Assembly

- Hexagonal duct with coolant tubes
- Compatible with vibrationally compacted (VIPAC) or specially formed “hexnut” pellet fuel
- Vented to reduce pressure-induced stresses in cladding and duct wall (as in GCFR of 1970’s)
- Very high fuel volume fraction (~63%) with tolerable core pressure drop.

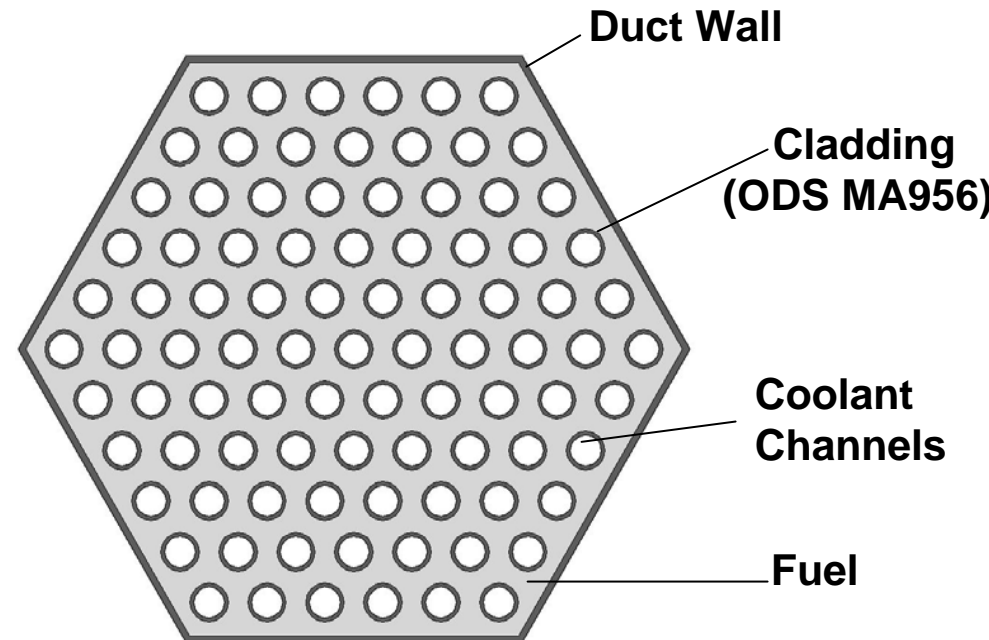

(Horizontal Cross Section)

Courtesy of CEA Cadarache. Used with permission.

4. CVW solution: Use of diluent to soften spectrum

$$\Delta\rho_{VOID} \propto \left(\frac{\sigma_c}{\sigma_f} \right)_{UNVOIDED} - \left(\frac{\sigma_c}{\sigma_f} \right)_{VOIDED}$$

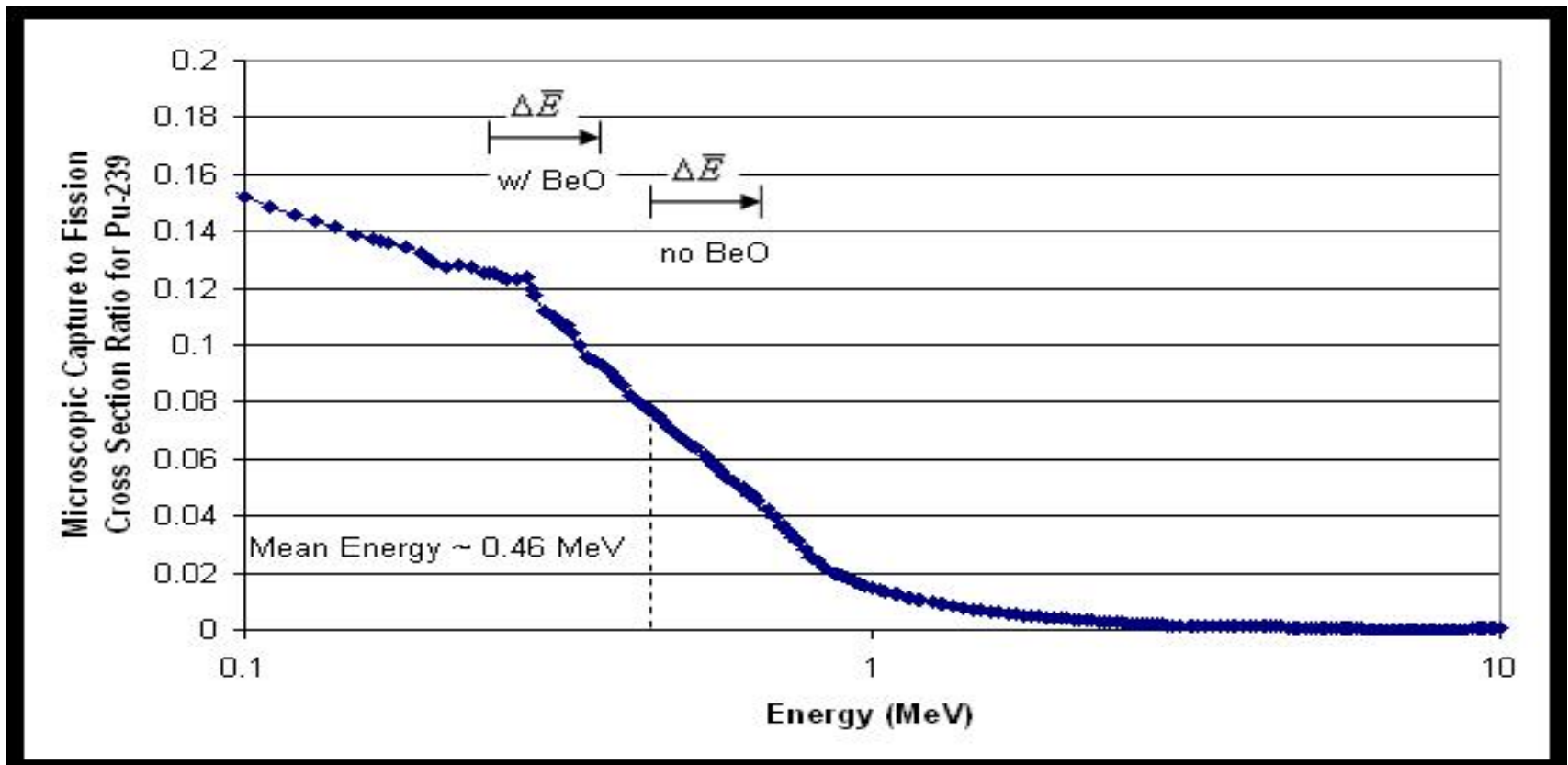

Neutron Energy Spectra of Fuel with BeO Diluent

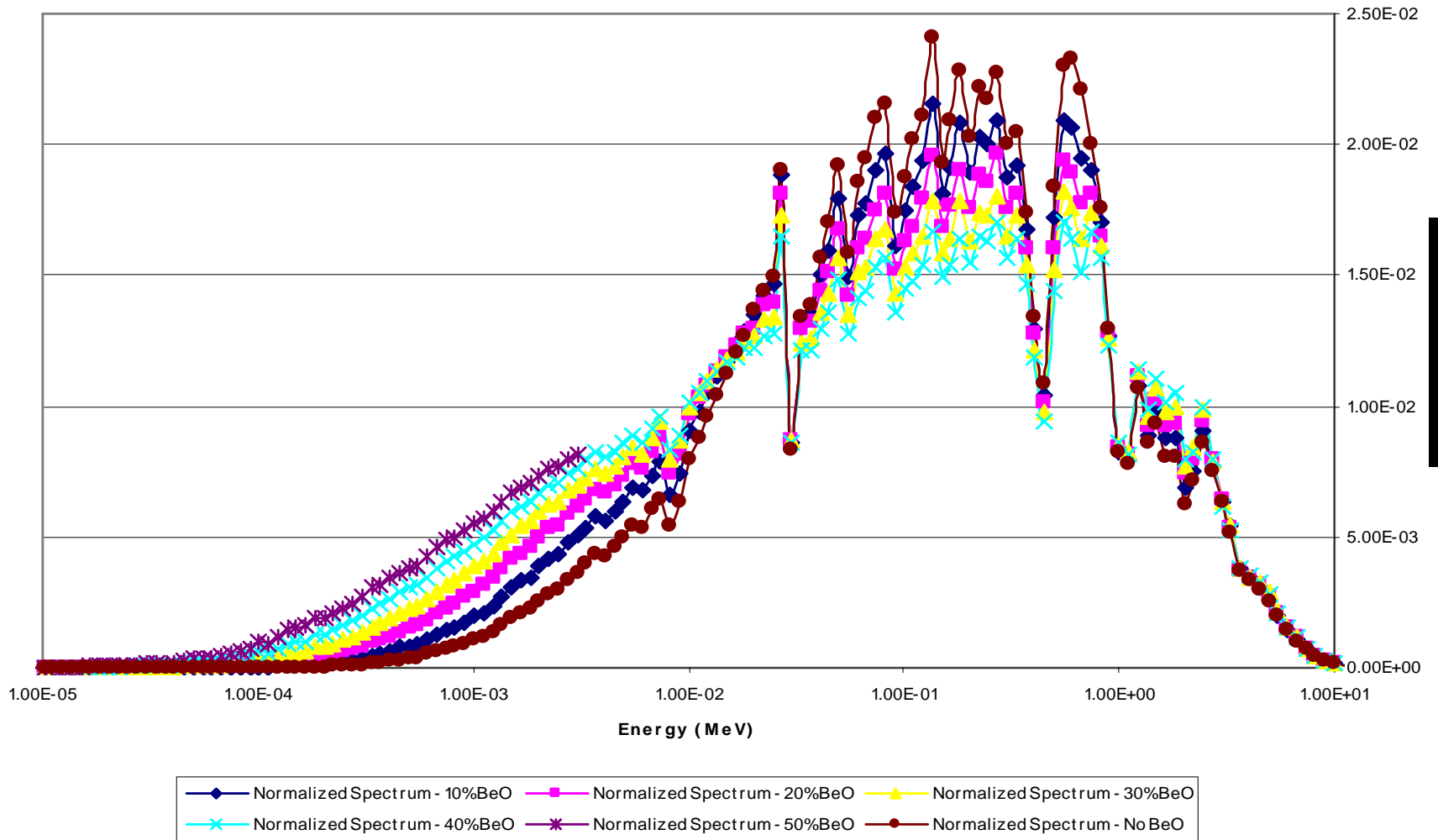

The Diluent Approach

- Without diluent, enrichment zoning
 - BOL $CVW=1.6\%$, radial peaking =1.56
- With BeO diluent, enrichment and diluent zoning
 - BOL $CVW=0.5\%$, radial peaking =1.15
- Diluent can also reduce axial peaking
- Shapes power by:
 - Displacing fuel
 - ◆ Minor effect
 - Softening neutron energy spectrum
 - ◆ Reduces neutron energy below fast fission threshold
 - ◆ Dominant effect
- BeO
 - Moderating effect
 - Thermal conductivity enhancement
 - Best CVR reduction among candidate options
- Other candidates
 - SiC
 - TiC

Radial Power Shaping Using BeO

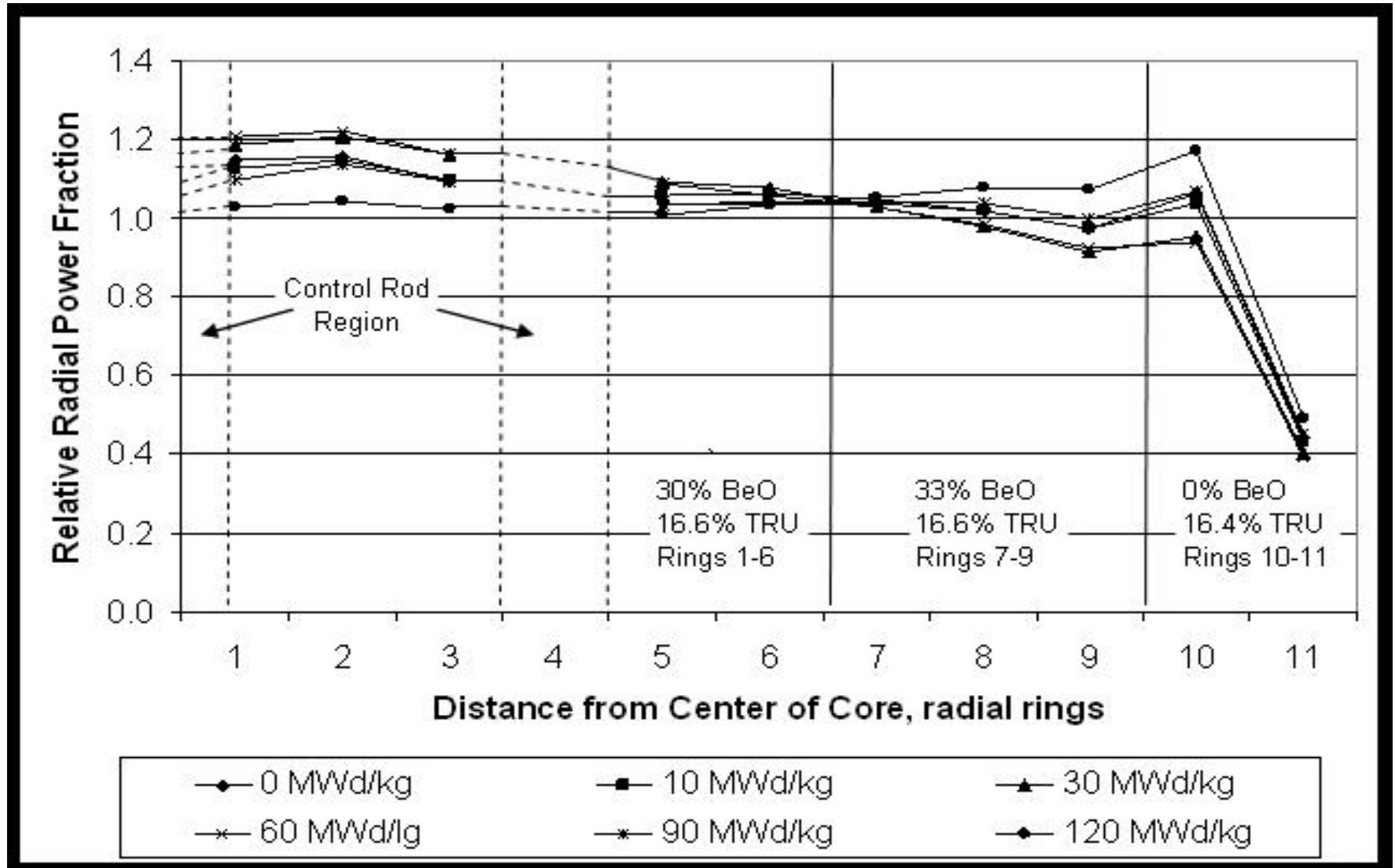

Other effects of diluent

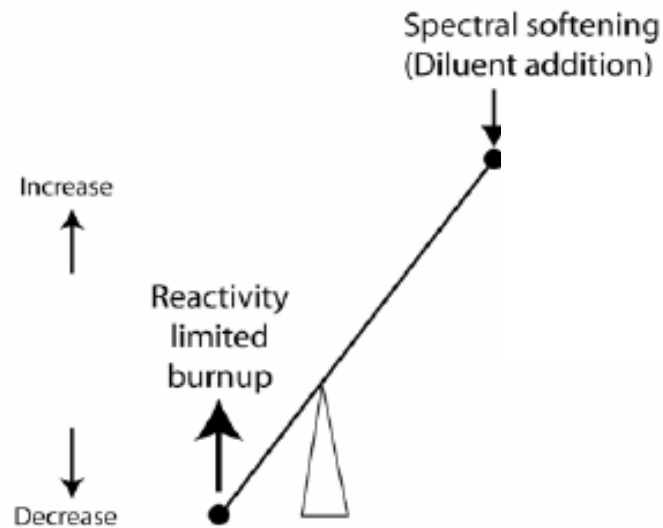
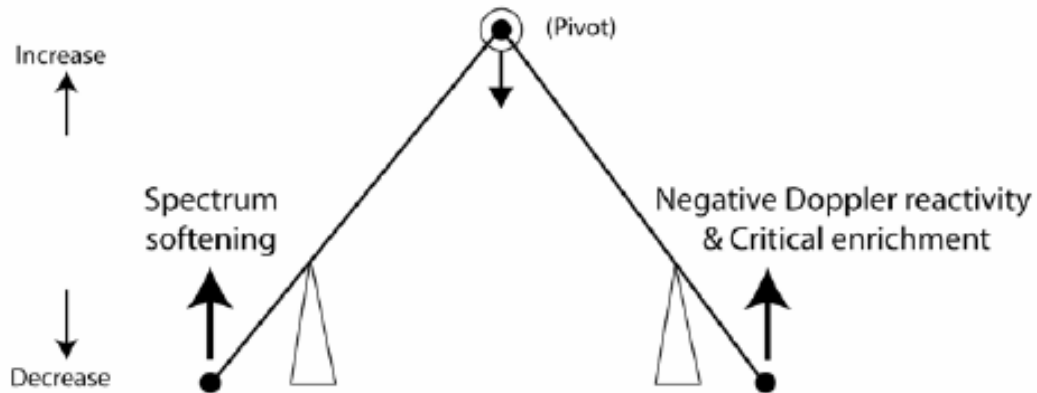

Consequences of sustainability-driven choices (Cont')

- **Difficult to achieve conversion ratio (CR) of 1.0 in the absence of blankets**
 - Balance between leakage/neutron economy and CVW
 - Balance thermal hydraulics and neutronics through coolant and fuel volume fractions

Why high heavy metal density?

- Unit cell calculations
- U fuels
- Heavier density fuels achieve higher BOL reactivity

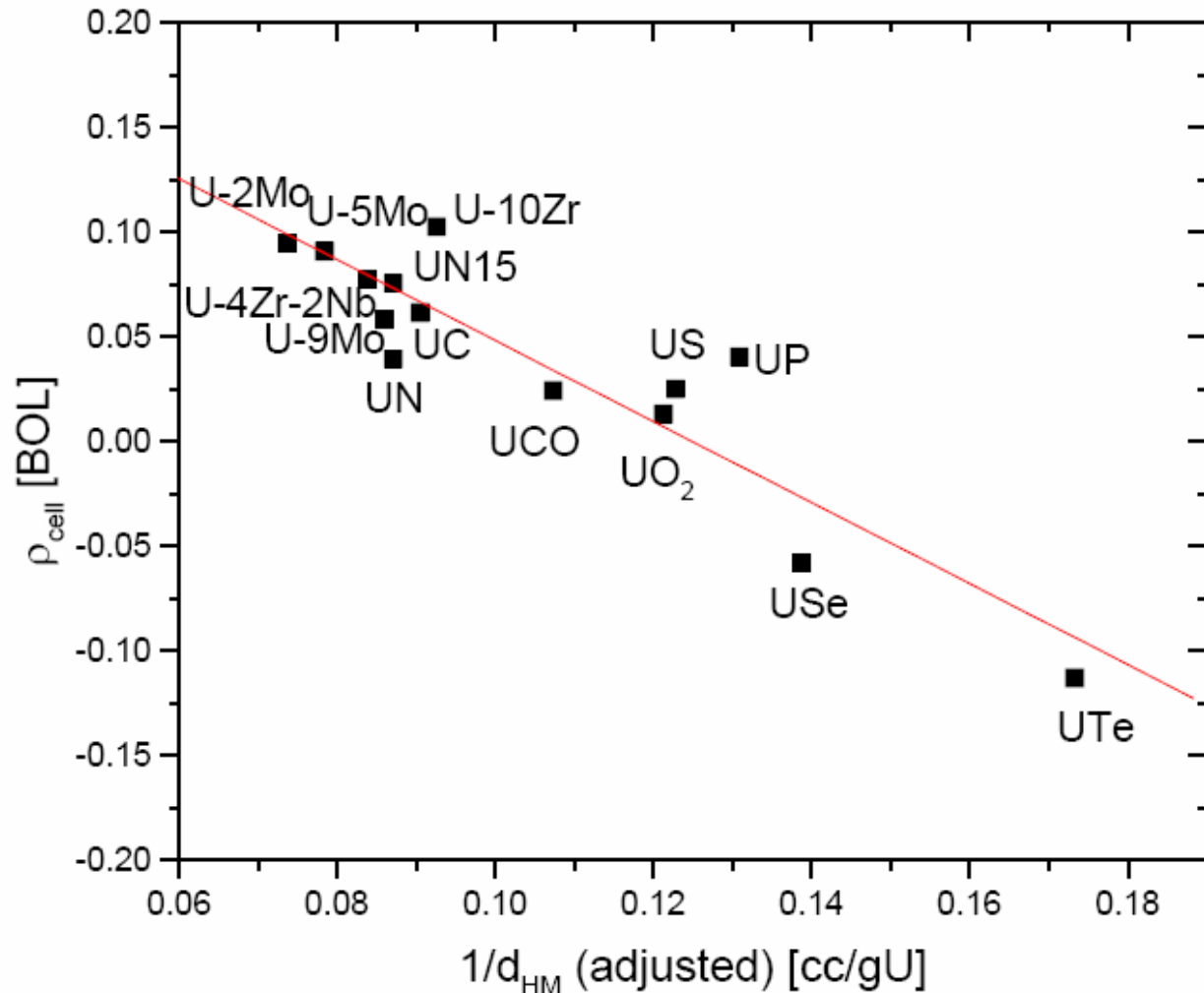

Gen IV Goals 3: Economy

- Indirect link
 - Capital cost via safety - examples
 - ◆ Reduced peaking allows higher power density for given structural material temperature limits, hence more energy from the same vessel and lower cost
 - ◆ Low reactivity swing reduces number of control rods (CRDs expensive)
- Direct link
 - Fuel cycle cost
 - ◆ Strive for low enrichment (TRU weight fraction)
 - ◆ Strive for high specific power

Example of long life, low power density design

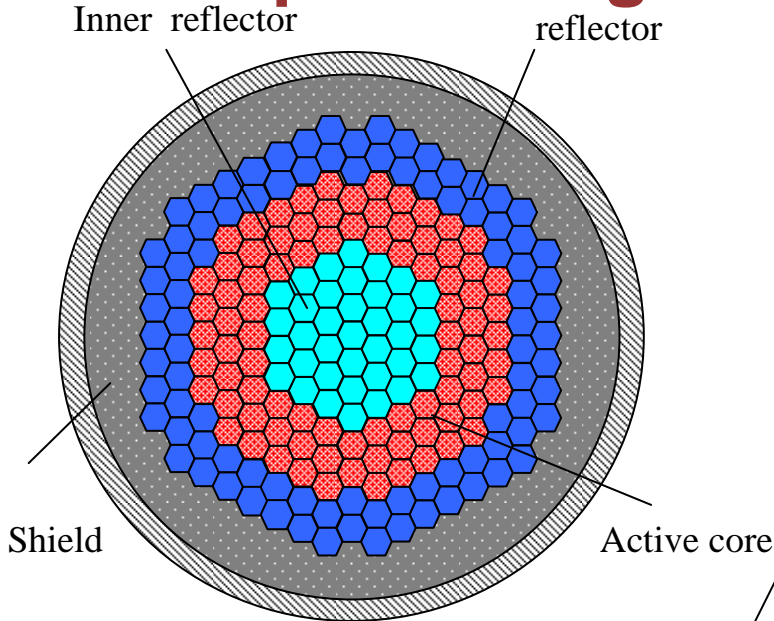

- Synergistic twin to thermal GT-MHR
- Same low power density – 8kW/l
- Passive decay heat removal by conduction and radiation
- Excellent safety
- Neutronically feasible
- Very long core life – 50 years

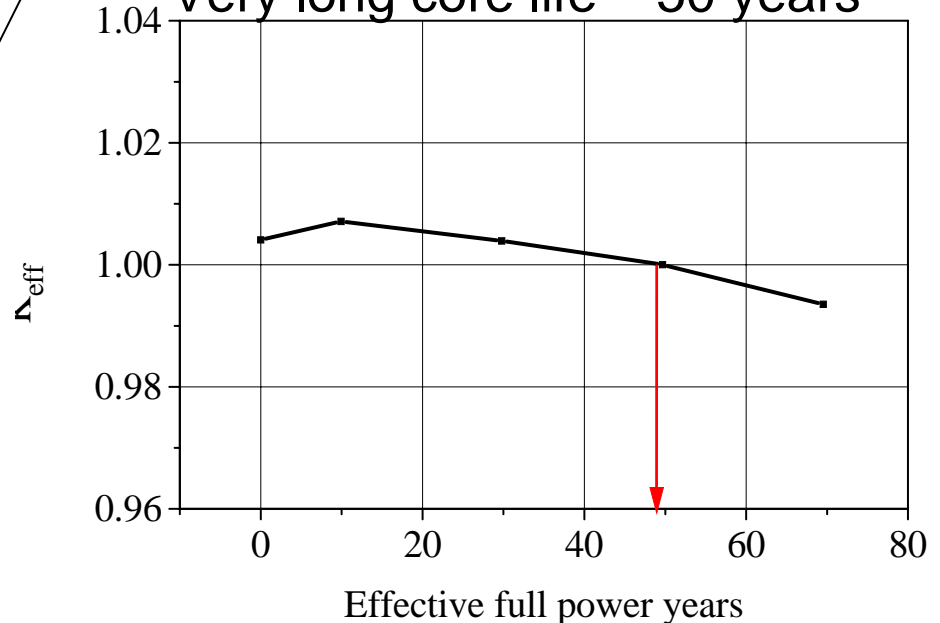
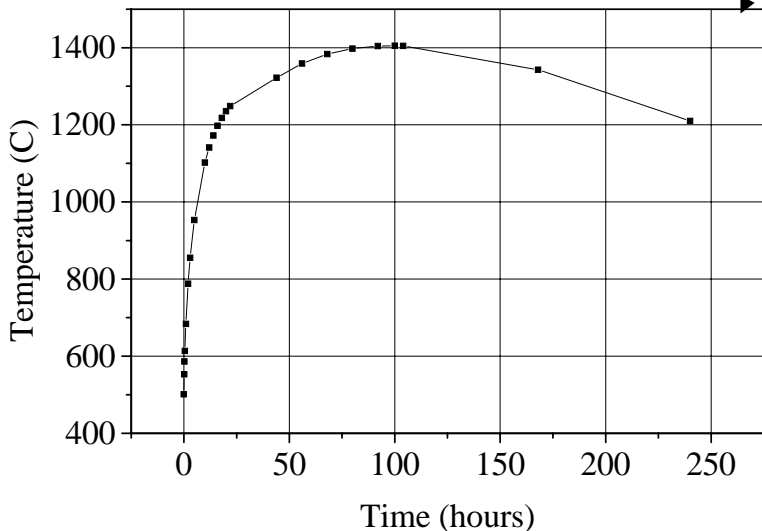

But very high fuel cycle cost!!!

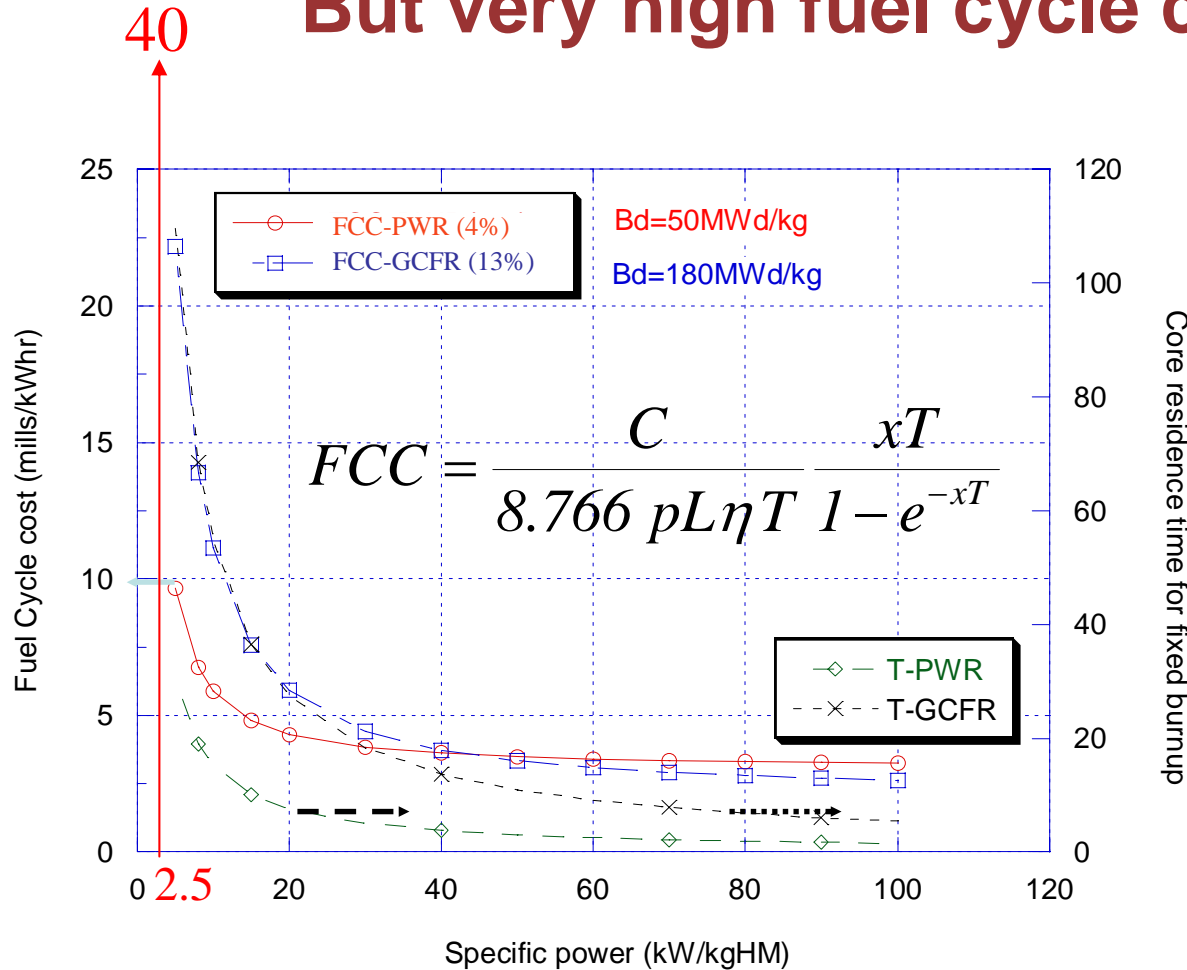

GFR

- For U235 enriched fuel
- $\eta=45\%$, $L=0.90$
- $Bd=180MWd/kgHM$
- discount rate $x=10\%/yr$
- $C=3936$ \$/kg for $e=13\%$

PWR

- $\eta=33\%$, $L=0.90$
- $Bd=50MWd/kgHM$
- discount rate $x=10\%/yr$
- $C=1200$ \$/kg for $e=4.5\%$
- Fabrication 200\$/kg
- $SP=38kW/kgHM$

- Twin to MHR-GT not economically feasible
- Specific power should not be much below 20kW/kg, Shoot for 25kW/kgHM (BWR)
- SUPERSAFE reactor of no use without a buyer
- What works for thermal reactor may not work for fast reactor

Gen IV Goals 4: Safety

- Reactivity increase from coolant depressurization
- Primary issue is **post LOCA decay heat removal**
 - Gen IV emphasis is on enhanced safety
 - Current trend – rely on passive means

GFR with natural circulation decay heat removal at elevated pressure

- 4x50% cooling loops
- after depressurization of primary system, containment pressure increases and provides elevated pressure needed for natural circulation

Requires

Low pressure drop core, hence large coolant volume fraction – but neutronics favors small coolant volume fractions

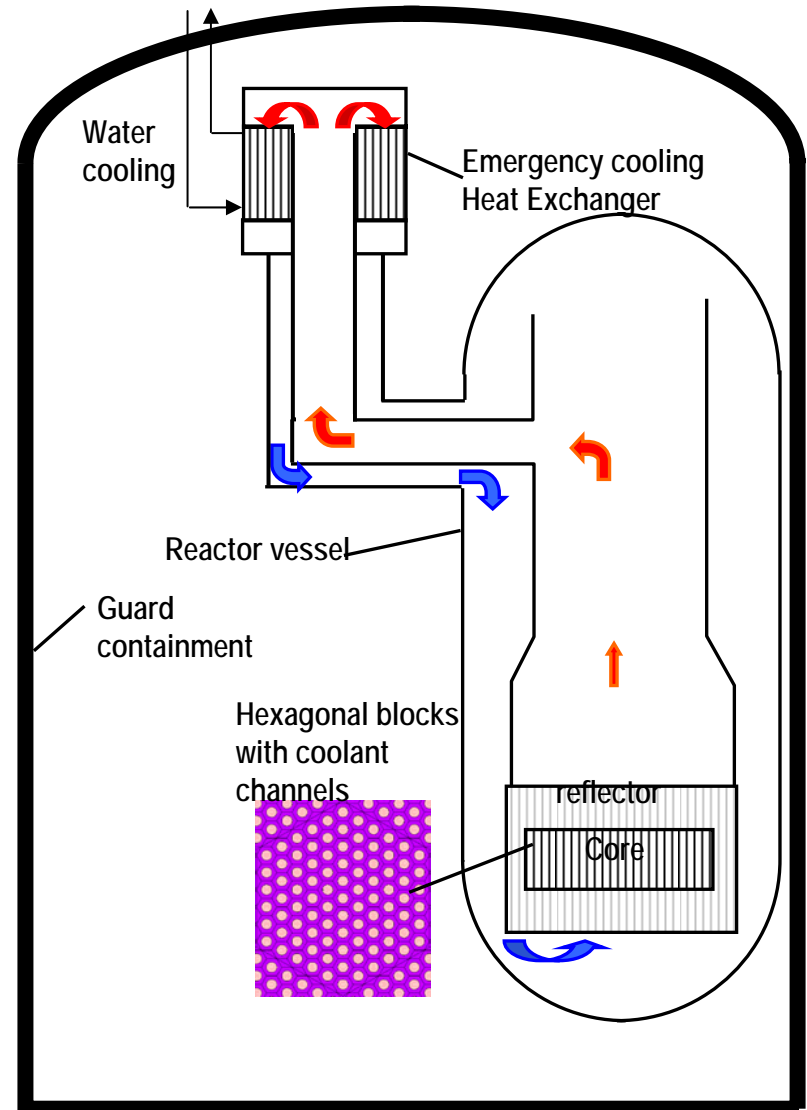

Approaches to reconcile neutronics thermal hydraulic requirements

- Problem
 - Neutronics needs high fuel volume fraction
 - Post-LOCA thermal hydraulics favors low pressure drop
- Use **inverted fuel assembly** or **plate fuel assembly**

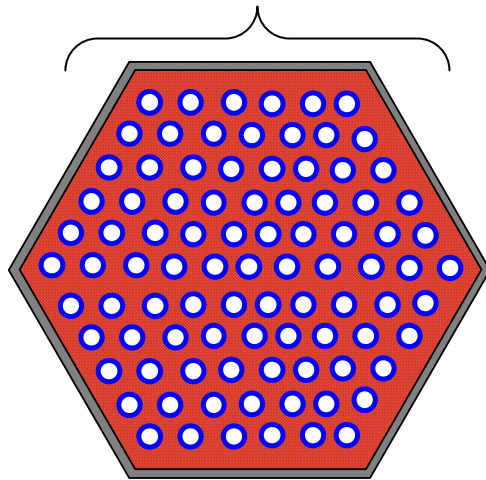

MIT approach

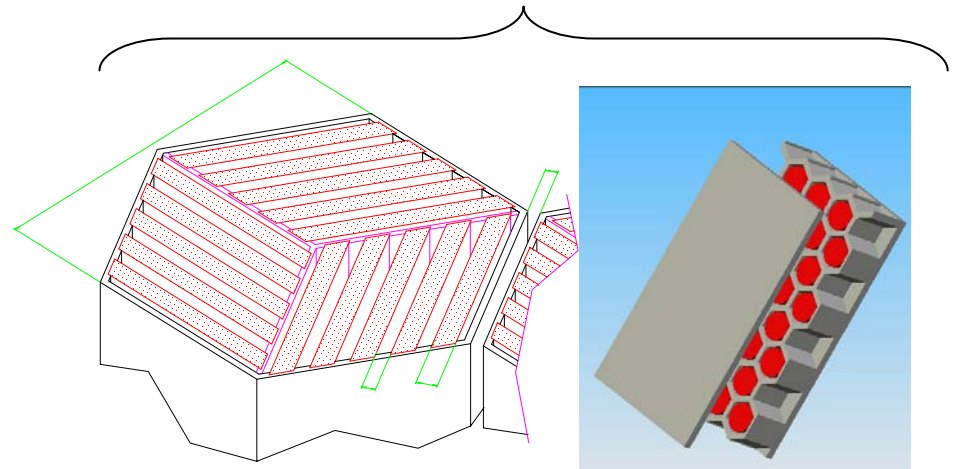

CEA approach

Courtesy of CEA Cadarache. Used with permission.

Neutronic Design for Safety

- Most GFRs have slightly positive CVW
- Is this acceptable?
- How to assure safety with slightly positive CVW?
 - Rely on other reactivity coefficients, which are negative
 - ◆ Doppler feedback
 - ◆ Fuel thermal expansion coefficient
 - ◆ Core radial expansion coefficient
 - ◆ CRD driveline expansions coefficient
 - Strive for a design with such a combination of reactivity coefficients that can achieve reactor shutdown without exceeding structural materials and fuel temperature limits

Possible Safety Approach

- Follow IFR approach of reactor self-controllability
- Goal: reactor should have sufficiently strong passive regulation of power to compensate for operator errors or equipment failures **even if the scram fails**.
- Core designed such that it inherently achieves safe shutdown state without exceeding temperature limits that would lead to core or vessel damage
- This must be achieved under the most restricting anticipated transients without scram (ATWS)
 - Unprotected (without scram) loss of flow (ULOF)
 - Unprotected loss of heat sink (ULOHS)
 - Unprotected overpower (UTOP) –
 - ◆ largest worth CRD withdrawal

Possible Safety Approach (cont')

- Note that this is much stronger requirement than for LWRs
- Loss of coolant is not credible in IFR since coolant under no pressure and if vessel fails, the coolant remains in guard vessel (but it is an issue in GFR, hence it needs to be accommodated)
- Inherent shutdown is determined by:
 - Reactivity feedbacks
 - Material and coolant-related limits (e.g., clad, boiling, freezing T for IFR)
- Need to find such combination of reactivity feedbacks and limits that makes it possible to achieve self-controllability

Safety Approach (cont')

- Quasi-static balance for reactivity encompassing all paths that affect reactivity is

$$0 = \Delta\rho_{power} + \Delta\rho_{flow} + \Delta\rho_{temp} + \Delta\rho_{external}$$

+ $\Delta\rho_{cvw}$ for GFR

- Since time constants of heat flow changes and temperature induced geometry changes and of delayed neutrons are in the range of half second to several minutes, and transients are slower, most feedbacks are linear permitting above equation to be represented as

$$0 = \Delta\rho = (P - 1)A + (P / F - 1)B + \delta T_{inlet} C + \Delta\rho_{external}$$

+ $\Delta\rho_{cvw}$ for GFR

P,F – power and coolant flow normalized to full power and flow

δT_{in} – change from normal coolant temperature

A,B,C – integral reactivity parameters that arise from temperature and structural changes - discussed next

Three criteria for A,B,C can be derived to achieve self-controllability

Self-controllability criteria for LMRs

- ABR – fertile free, lead cooled actinide burner
- LMRs can be designed to satisfy these criteria in spite of positive CVW
- Transient calculations still needed to confirm the performance

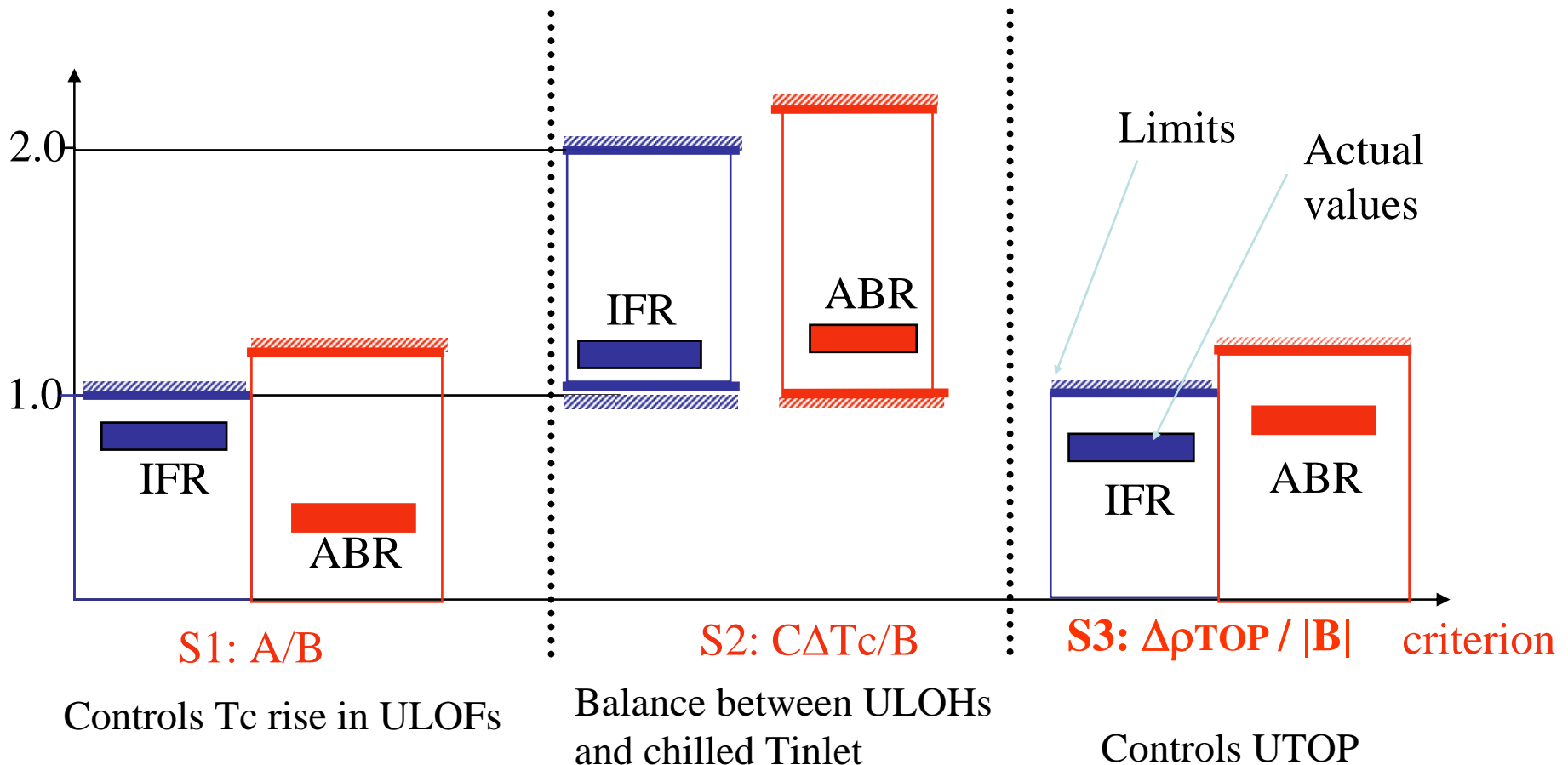

GFR self controllability

- Designing a GFR with self controllability is a challenge
- Differences
 - Additional term in reactivity balance to account for CVW
 - Direct cycle – separate ULOHS and ULOF may not be possible – loss of heat sink (precooler) may lead to loss of flow to prevent compressor surge or stall, hence ULOF and ULOHS will be always combined
 - Self-controllability criteria need to be updated
 - Decay heat removal may not be fully passive
- Issues
 - MIT design with UO₂ fuel has too large Doppler feedback (low conductivity, softer spectrum)

Questions



Extra Slides

Natural circulation performance - CO₂ and He

Post LOCA core temperature profiles

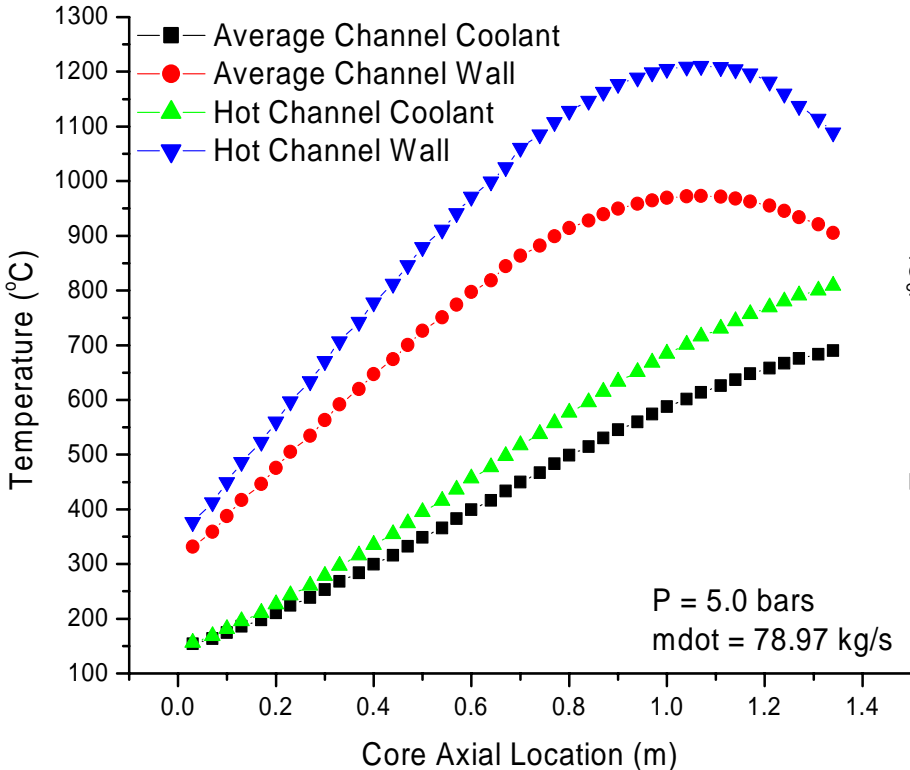

CO₂

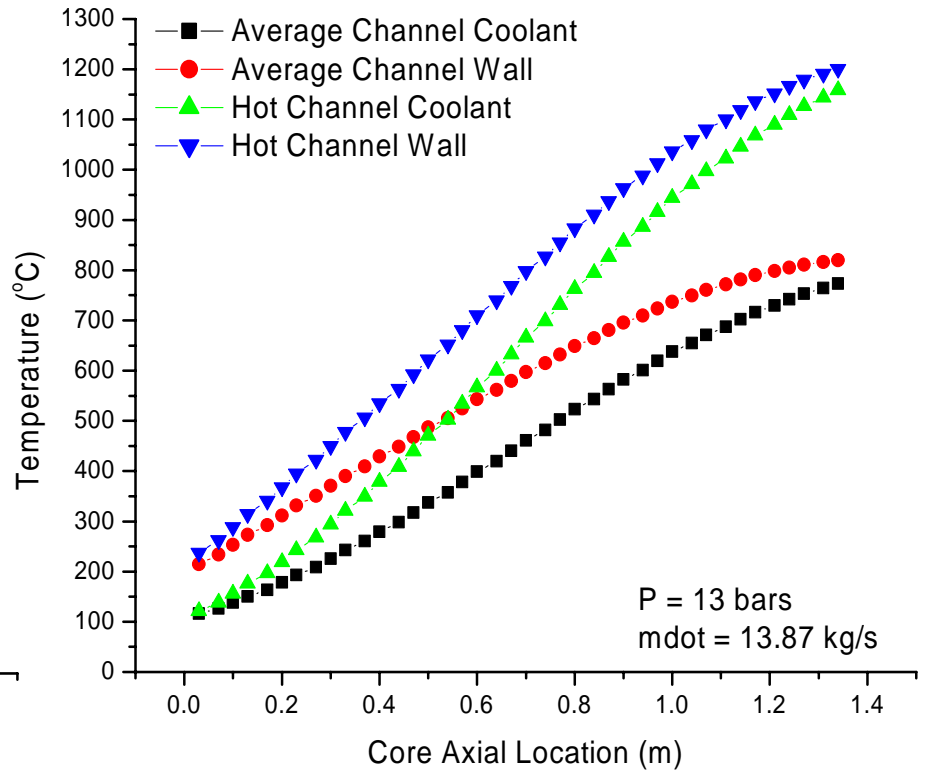

Helium

- Limits – peak cladding temperature = 1200°C, maximum core-average outlet T = 850°C
- 2% decay heat can be removed by natural circulation
- CO₂ much better than He – requires backup pressure of 5 bars versus 13 bars for He
- Helium – issue of excursion type instabilities

IFR criteria for passive self-regulation

S1-criterion **$A/B < 1.0$; A,B negative**

- A-net power reactivity coefficient (Doppler, fuel thermal expansion)

$$A = (\alpha_d + \alpha_{th}) \Delta T_f [\phi]$$

- B-power/flow coefficient of reactivity - controls asymptotic temperature rise in ULOF (coolant density, CRD-driveline, core radial expansion coefficients)

$$B = [\alpha_d + \alpha_{th} + \alpha_{den} + 2(\alpha_{crd} + 2/3\alpha_{rad})] \Delta T_c / 2 [\phi]$$

- Key strategies:
 - Small negative A - metallic fuel, hard spectrum
 - Large negative B - minimize coolant density coefficient
- Large B also favors large temperature rise across the core
- But penalties on efficiency, hence compromise needed

IFR criteria for passive self-regulation

S2-criterion $1.0 < (C \Delta T_c / B) < 2.0$; **C negative**

- C –inlet temperature coef. of reactivity = $-\left[\partial\Delta\rho / \partial T_{in}\right]$
- provides balance between the ULOHS and the chilled inlet temperature inherent response (Doppler, fuel thermal exp., coolant density core, radial exp.)

$$C = (\alpha_d + \alpha_{th} + \alpha_{den} + \alpha_{rad}) [\phi/K]$$

- range comes from cladding limit and coolant temperature rise
- Main efforts:
 - Minimize coolant density coefficient
 - Increase core radial expansion coefficient, if needed

IFR criteria for passive self-regulation

$$\text{S3-criterion} \quad \Delta\rho_{\text{TOP}} / |\mathbf{B}| < 1.0$$

- Controls asymptotic temperature rise in UTOP
- The rod worth of the most reactive control rod must be limited
- Strategies:
 - Minimize reactivity swing
 - Use fertile, maximize η , CR=1 is a good candidate
 - Increase V_f - limited by cladding stress constraint
 - Low-leakage core favored, but hurts coolant void worth
 - Large B - minimize coolant density coefficient
 - Increase number of CRDs

Feasibility domain for plate core at 50kW/l

- Feasibility domain for carbide CERCER (50/50) 2400MWth core $q''' = 50\text{W/cc}$

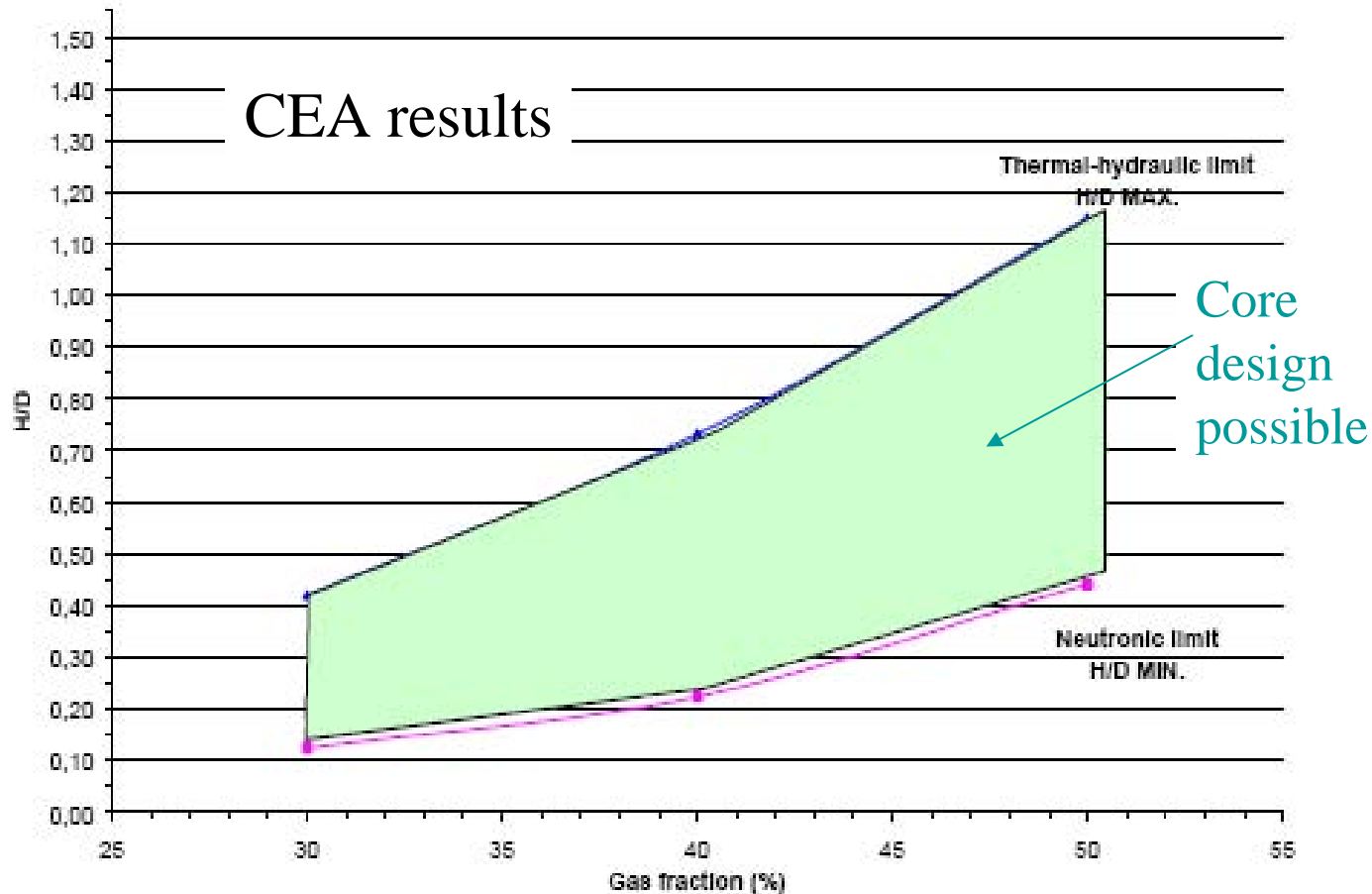

Feasibility domain for plate core at 100kW/l

- Feasibility domain for carbide CERCER (50/50) 2400MWth core $q''' = 100\text{W/cc}$

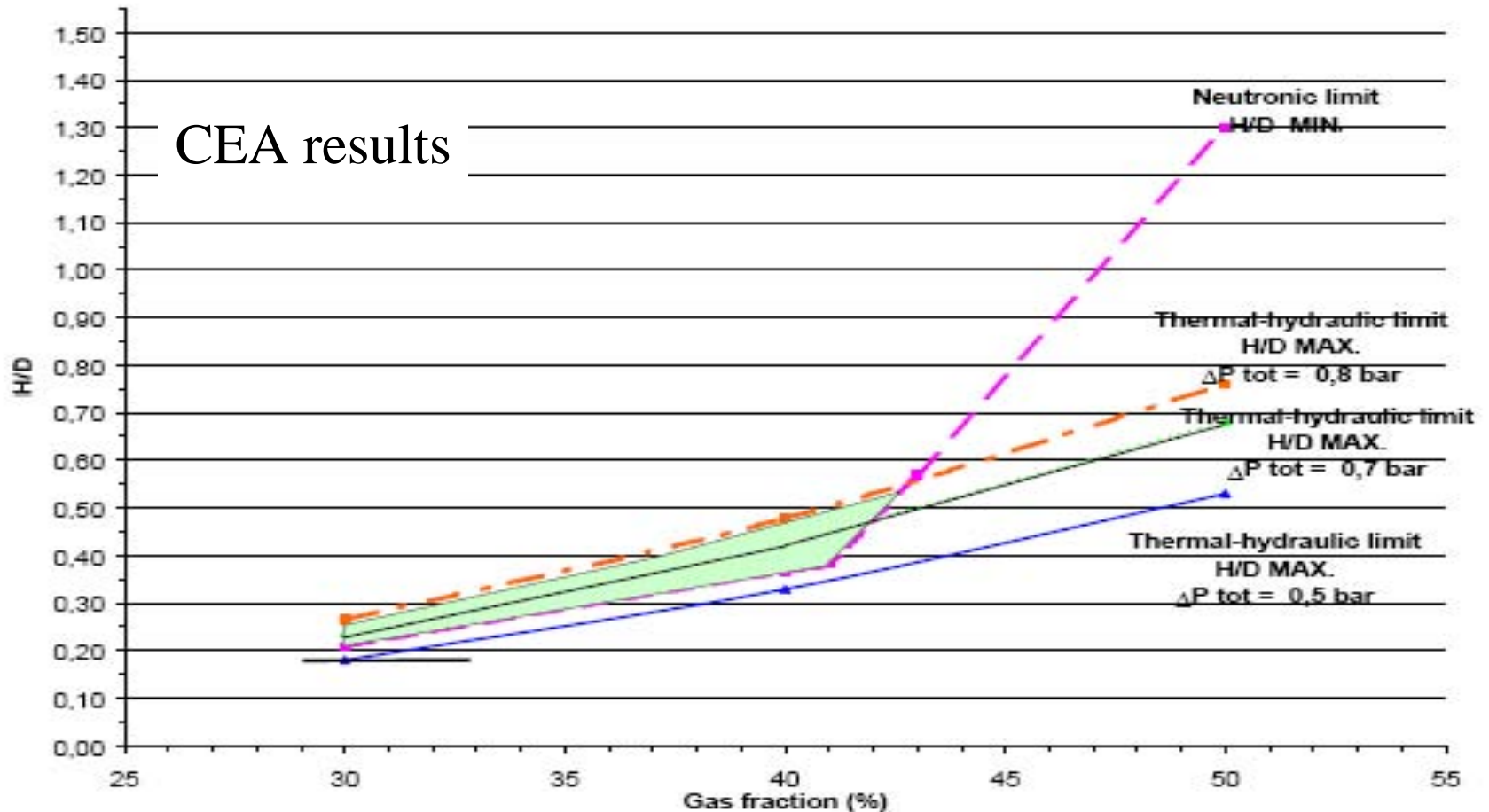

Typical reactor response to ULOF

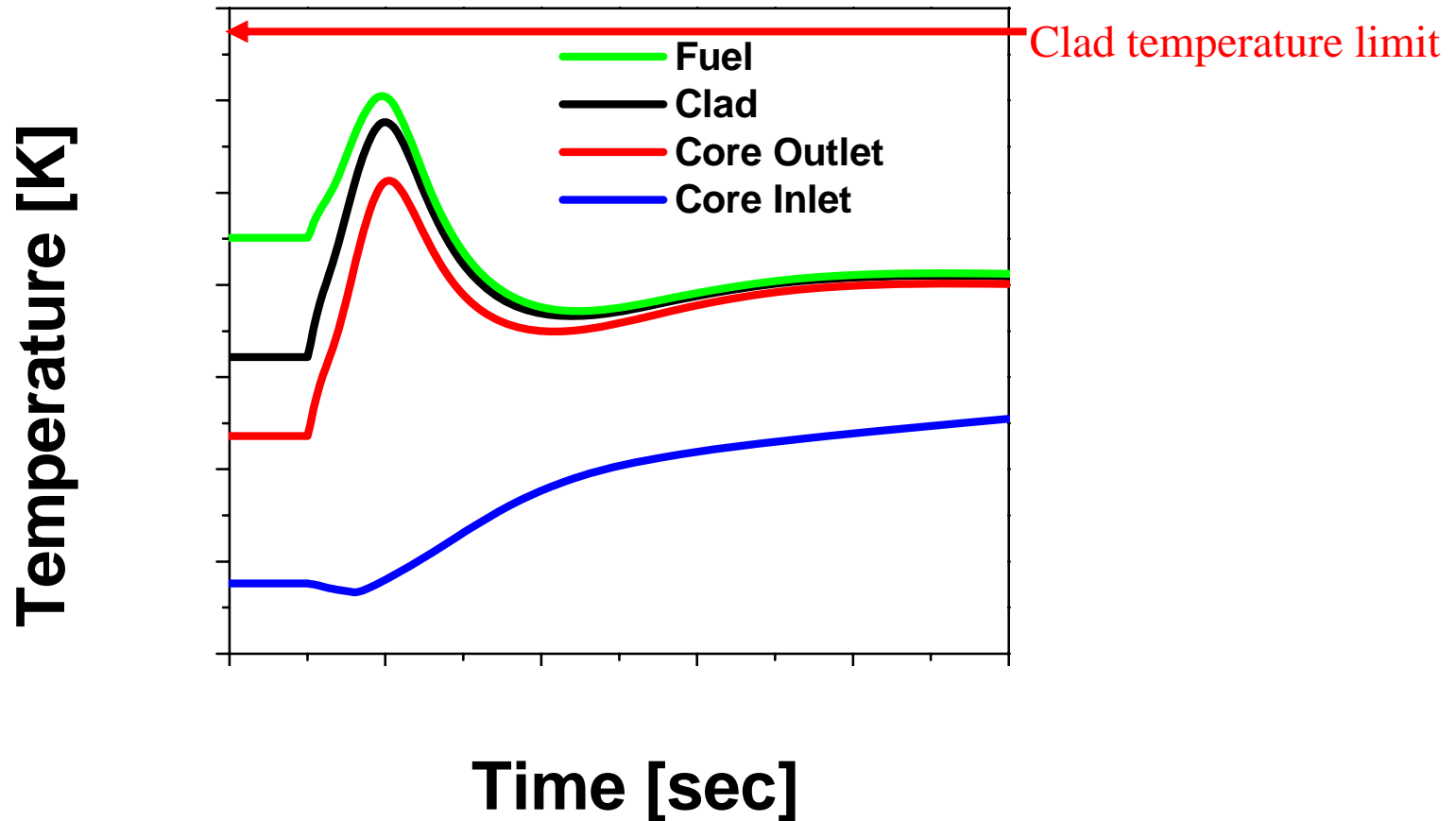

- Cladding must remain below temperature limit

Example of GFR design for passive decay heat removal

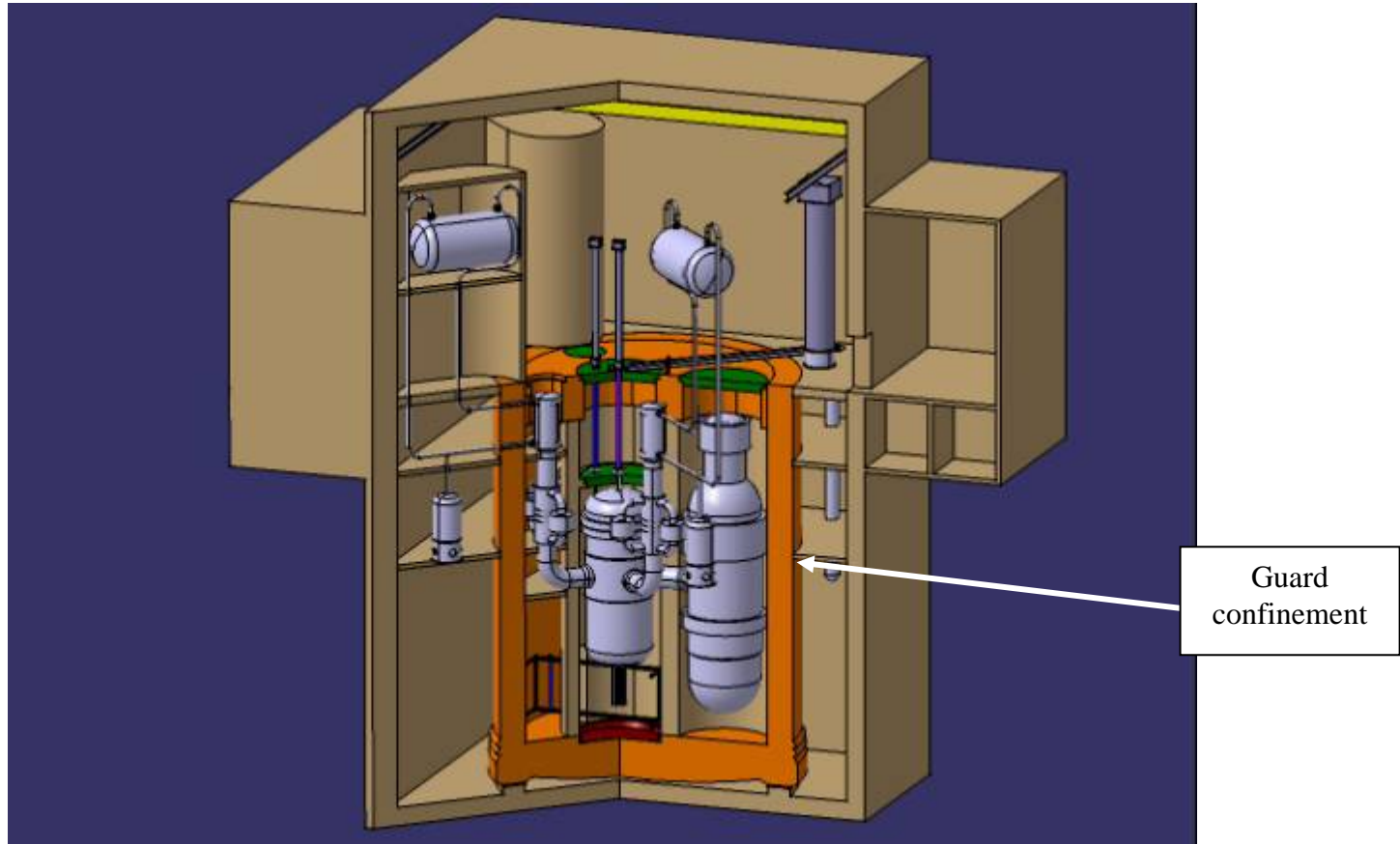

Courtesy of CEA Cadarache. Used with permission.

CEA and Framatome helium cooled design

Example – neutronic data for CEA design

Table 2.3: Neutronics characteristics – 2400 MWt Plate Core

	First cycle	Equilibrium cycle
Power density (MW/m ³)	100	
TRU enrichment (%)	15.2	18.5
U+Pu+MA inventory (tons)	59.3	59.3
Pu / MA inventory (tons/GWe)	7.7 / 0	9.5 / 0.6
Core management EFPD	3 × 831 = 2493	
Average, Max burn up (at%)	10.1 / 14.7	10.1 / 14.7
Max damages (dpa SiC)	163	152
Average flux level – BOL (n.cm ² .s ⁻¹)	16.7 × 10 ¹⁴	15,9 × 10 ¹⁴
Max fast flux >0.1MeV (n.cm ² .s ⁻¹)	11.7 × 10 ¹⁴	11.0 × 10 ¹⁴
Breeding Gain - BOL / EOL	-0.07 / -0.04	0.05 / -0.05
Doppler Constant - BOL / EOL (10 ⁻⁵)	-1872 / -1175	-1405 / -968
He depressurization - BOL / EOL (10 ⁻⁵)	212 / 253	253 / 257
Delayed neutron fraction - BOL / EOL (10 ⁻⁵)	388 / 344	347 / 332

Courtesy of CEA Cadarache. Used with permission.

Example – key design data for CEA design

Table 2.2: Design data and Thermal-hydraulics– 2400 MWt Plate Core

Power density (MW.m ⁻³)	100
Active core volume (m ³)	24
Core diameter/height (m)	4.44 1,55
H/D	0.35
(U,Pu)C (% vol.)	22.4
SiC structures (%vol.)	26.4
Gas (% vol.)	51.2
He coolant / He gaps	40.1 / 11.1
Plate thickness (mm)	7 (including 2 × 1 mm for plate closure)
Plates per S/A (in a plan)	27
Number of fuel S/A	387
Core pressure drop (bar)	0.6
Tmax** cladding BOL (°C)	1075
Tmax** fuel BOL (°C)	1210

**taking into account a correction for plate macro-structure heterogeneity