

Natural examples of degenerate reactions in 2-component systems.

① Interaction of a 3 ϕ equilibrium with a critical curve.

Ex = pyroxene

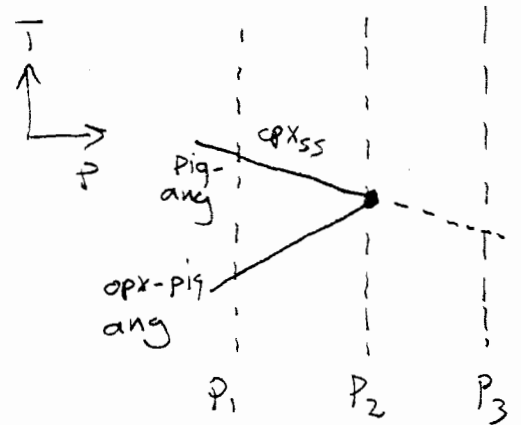
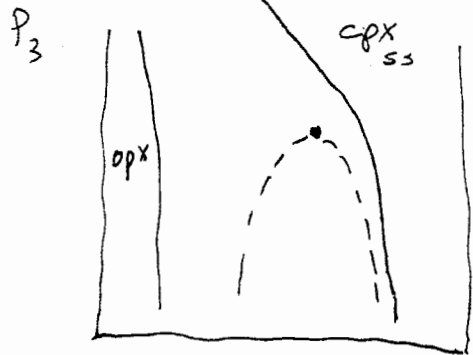
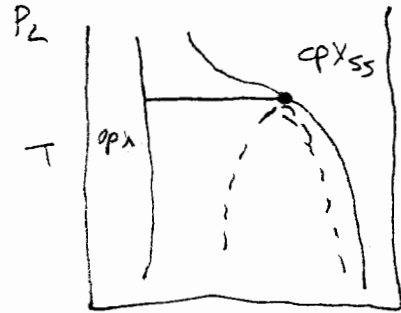
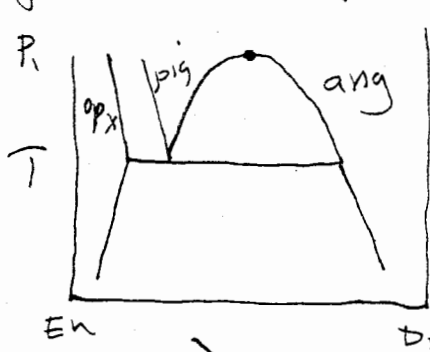

② Interaction of a 3 ϕ equilibrium and a coincidence in composition and critical curve.

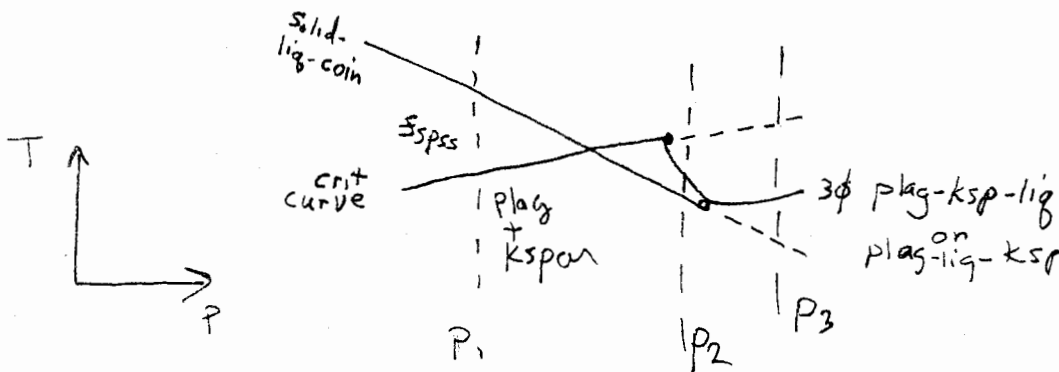
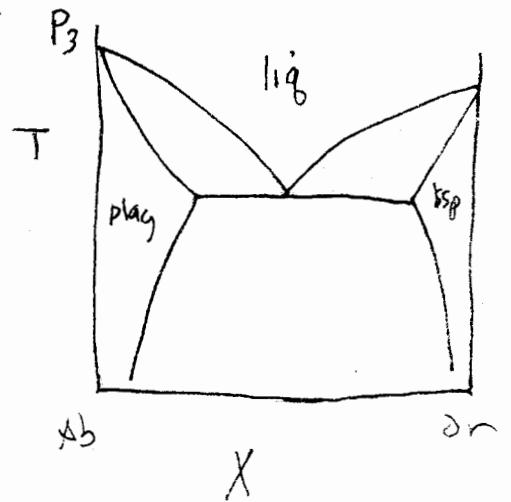
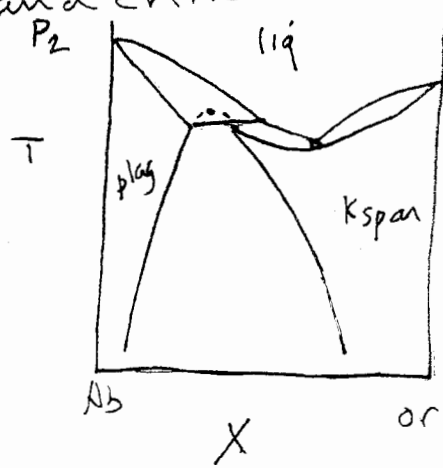
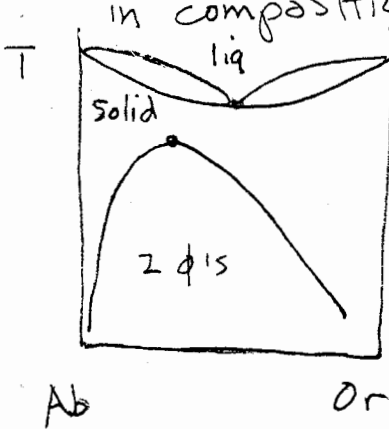

Colinearities in Ternary Systems

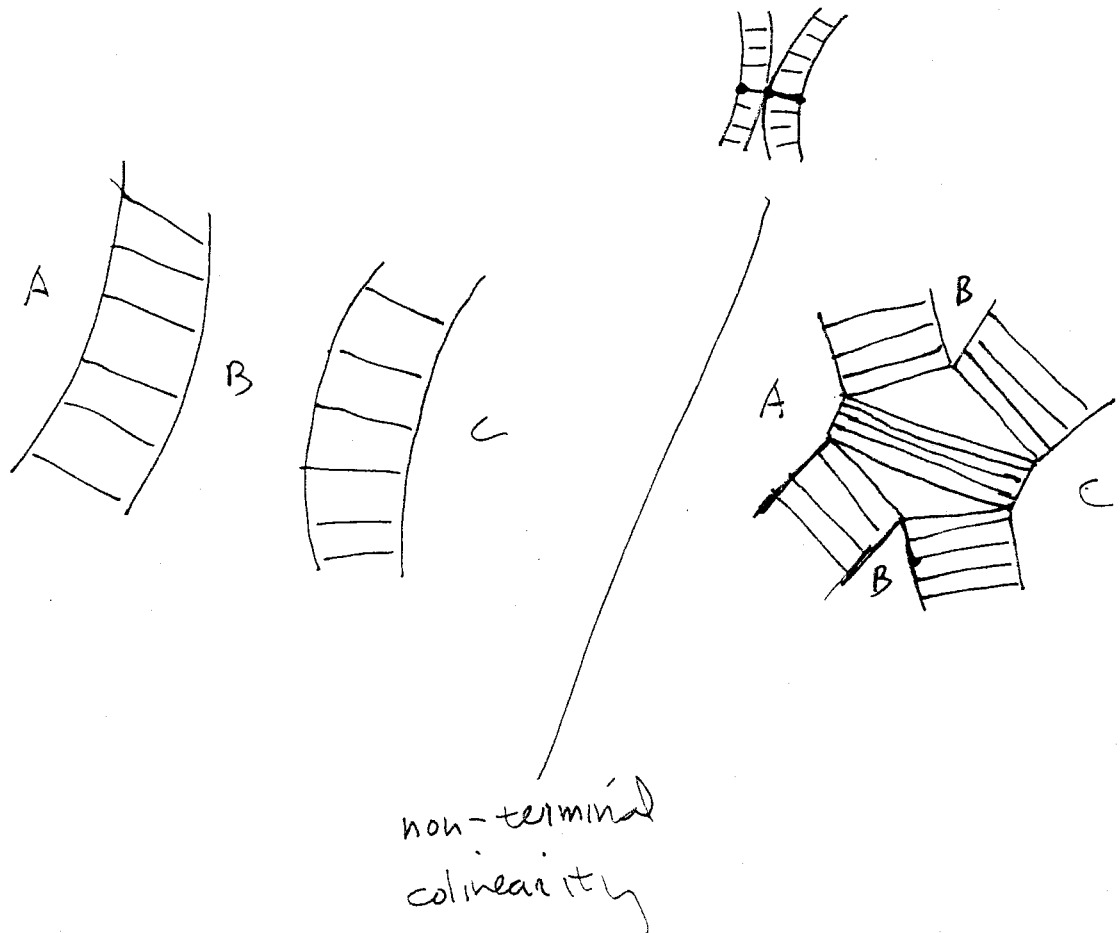
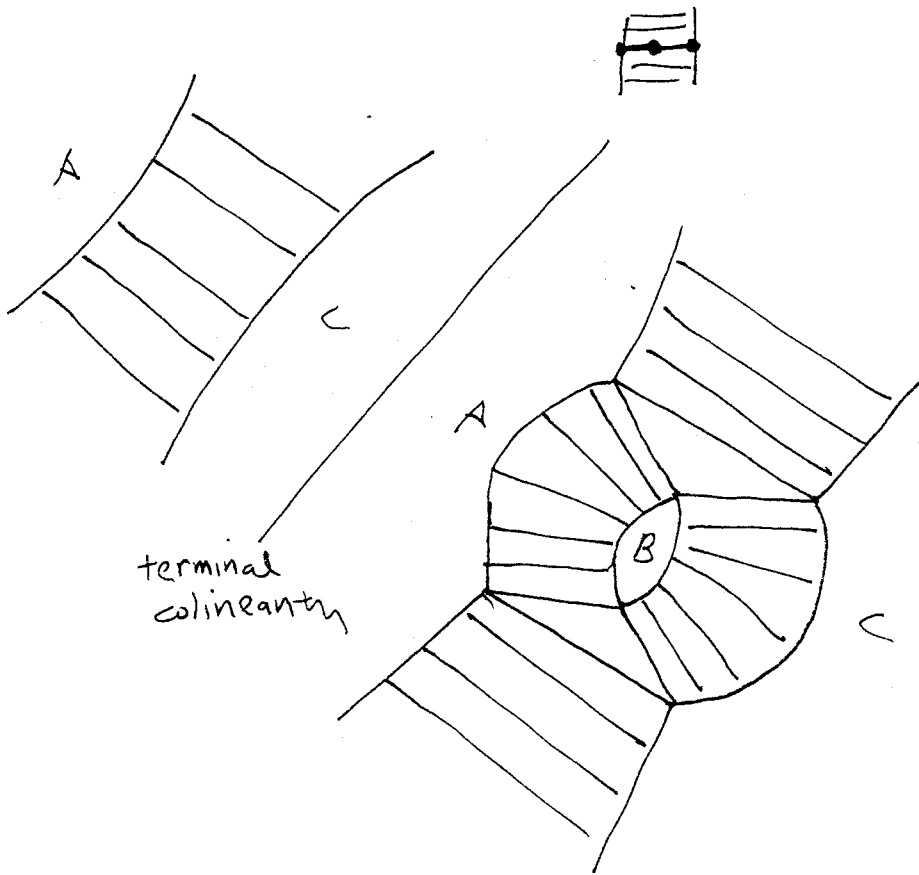

Fe - La - SiO₂ - non-terminial

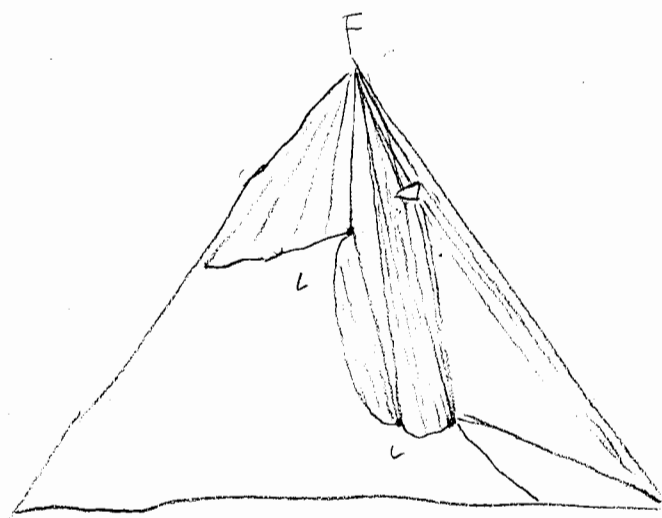
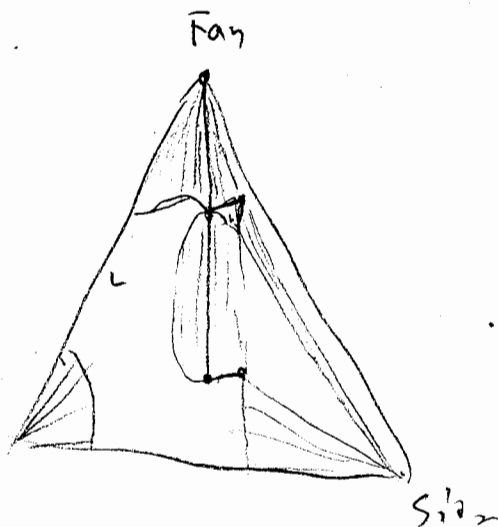
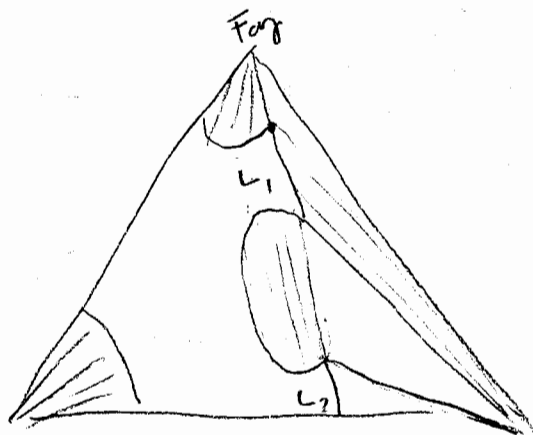

terminal - do ternary SiO₂ - Ab - Or

distrib.

phase appears at lower T

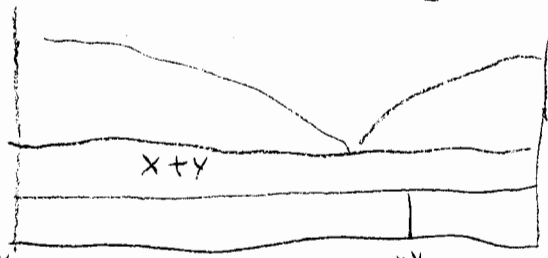
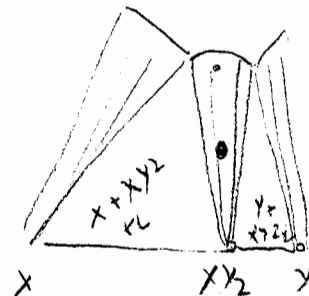
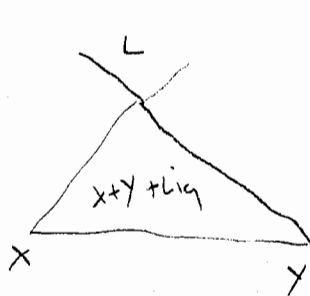
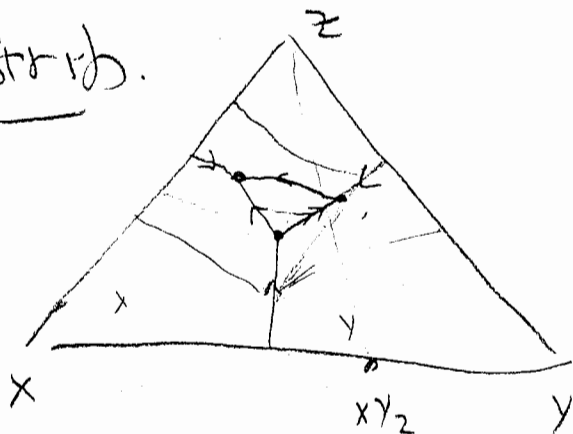

X only at ends.

