

A sketch of the central nervous system and its origins

G. E. Schneider 2014

Part 9: Hypothalamus & Limbic System

MIT 9.14 Classes 31

**The vertebrate medial pallium;
in mammals: the hippocampal formation
(Limbic system 4)**

Book chapter 28

Terms (review)

- “Limbic Telencephalon”: the endbrain structures strongly connected to the hypothalamus
- “Pallium” means cloak or mantle. All the cortical structures of the endbrain are included; the medial pallium includes the hippocampus.
 - The basal forebrain structures reach the ventral surface of the endbrain rostral to the hypothalamus, but are not considered pallial in nature; they are part of the ventral striatum.

Related functional topics

- Spatial memory
- Place cells and head-direction cells
- Hippocampal synaptic enhancement and information storage
- Acetylcholine and memory

Questions, chapter 28

see following pictures

1) Describe differences between place cells and head direction cells as recorded in rats. How are shifts in head direction signaled to the endbrain?

Via mammillothalamic tract to anterior thalamic nuclei to cingulate &

2) Describe the major difference between place cells in the dorsal and the ventral hippocampus in rats.

smaller
regions

larger regions
+ more connections to amygdala

Hippocampal Place Cells

Responses of 80 simultaneously monitored hippocampal cells recorded in a rat during exploration of a rectangular environment. Each square depicts that environment, and the activity of a single cell as the rat moves through the environment, with red denoting high activity and blue low activity at that location. Note that some cells respond only to a particular region of space, other respond over the entire environment, and many are nearly silent throughout.

Figure removed due to copyright restrictions.

Please see course textbook or: Wilson, Matthew A., and Bruce L. McNaughton. "Dynamics of the Hippocampal Ensemble Code for Space." *Science* 261, no. 5124 (1993): 1055-8.

from M. Wilson's Website, M.I.T.

Terms:

- Allocentric direction θ
- Egocentric direction
- Head direction cells (HD cells) $\theta + \Delta\theta$

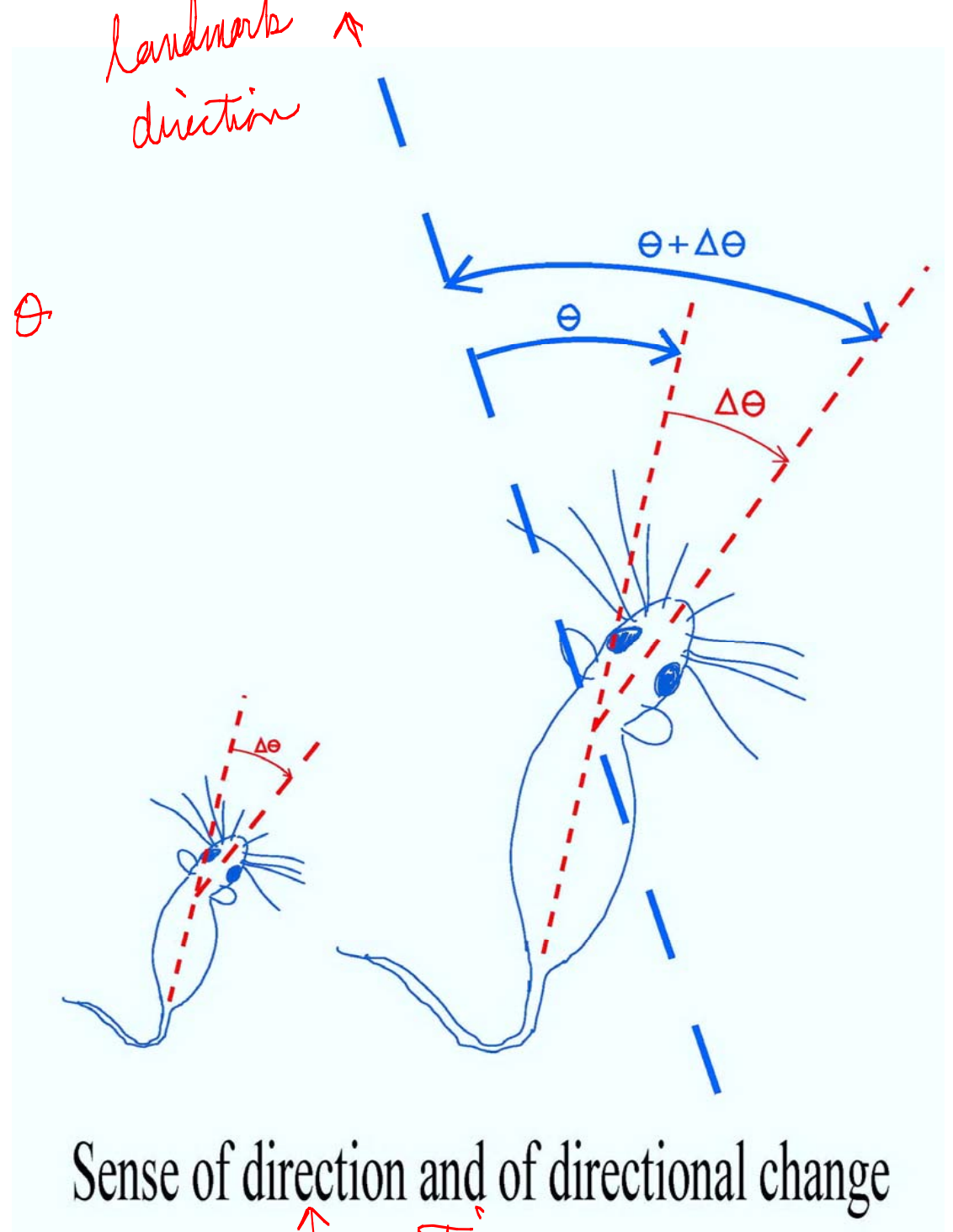

Fig 28-2

Courtesy of MIT Press. Used with permission.

Schneider, G. E. *Brain Structure and its Origins: In the Development and in Evolution of Behavior and the Mind*. MIT Press, 2014. ISBN: 9780262026734.

From chapter 26

Papez' circuit brought up to date

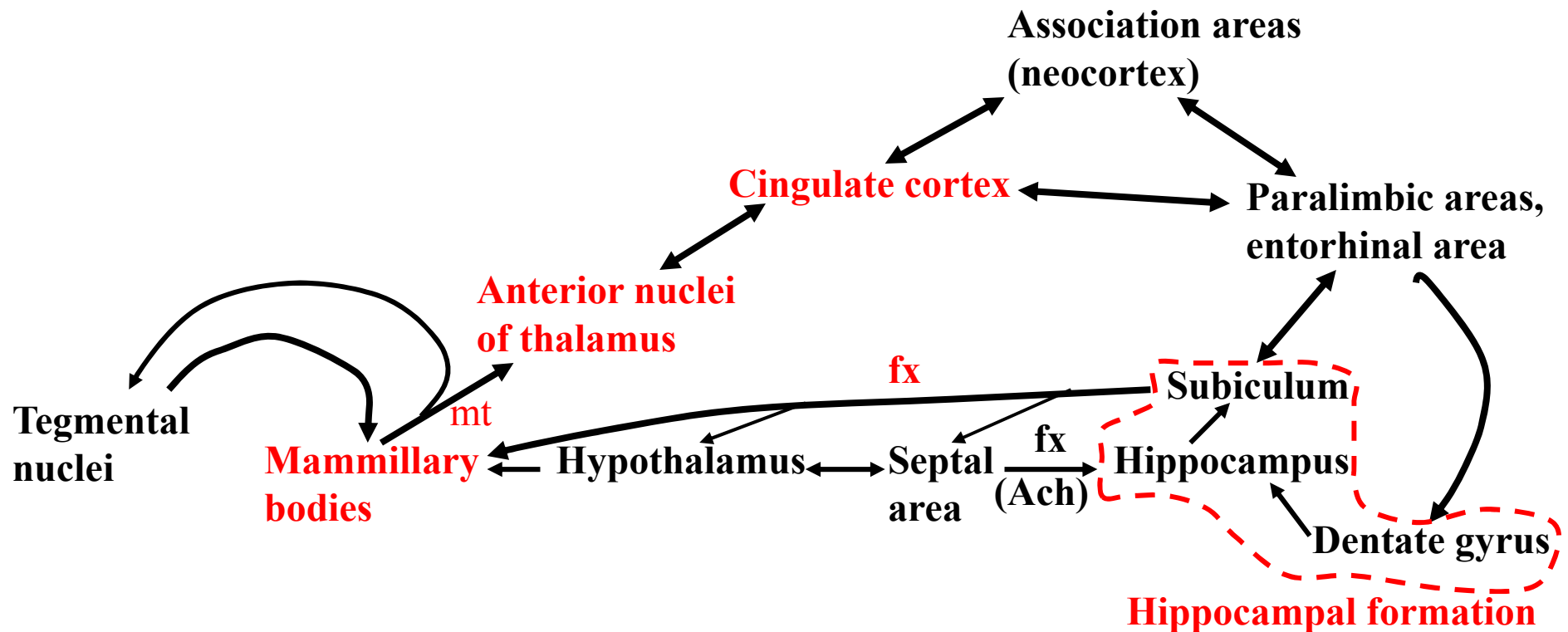

mt = mammillothalamic tract

fx = fornix bundle (output of hippocampus)

Courtesy of MIT Press. Used with permission.
Schneider, G. E. *Brain Structure and its Origins: In the Development and in Evolution of Behavior and the Mind*. MIT Press, 2014. ISBN: 9780262026734.

From chapter 26

- Changes in head direction are signaled by vestibular and related systems in the brainstem. $\Delta \theta$
- The signals come *via* tegmental nuclei to the mammillary bodies.
- The mammillary bodies (MM) also receive information on allocentric direction faced by the body from the hippocampus. θ
- HD cells of the MM, changing as the head shifts direction, represent allocentric direction of the head. $\theta + \Delta \theta$
- Relevance to hippocampal place representations: The place of the animal in its internal map of the environment and its anticipated changes are constantly being updated. For this, information on head direction is of great importance. (Next slide)

Functional significance: additional questions and ideas

- *Suggestion:* The ascending axons of this circuit are continuously activating memories of places that lie ahead, in the direction indicated by the current direction of the head.
- Axons in the circuit of Papez are of more than one type. Only the ones signaling head direction have been characterized.
- *What is the hippocampus sending to other parts of the hypothalamus?*
 - *It may alter motivational levels according to remembered information about locations in the current frame of reference.*
 - *(Early in the evolution of hippocampus, there was probably only one frame of reference for the internal map.)*

Questions, chapter 28

- 3) Contrast the learning manifest in the two major links between olfactory inputs and motor outputs as proposed for primitive vertebrates.

This brings us back to the evolutionary origins of the medial pallium:

- Remember the origins of the endbrain: The structures underlying olfaction
- **Two major links between olfactory system and the motor systems of the midbrain:**
 - 1) Through the ventral endbrain, which became corpus striatum and basal forebrain (including much of the septal area)
 - 2) Through the medial part of the dorsal endbrain, which became medial pallium—the hippocampal formation

Evolutionary origins of the medial pallium (amplifying this outline):

- Origins of endbrain: Structures underlying olfaction
- Two major links between olfactory system and the motor systems of the midbrain
 - 1) Through the ventral endbrain, which became corpus striatum and basal forebrain (including much of the septal area)
 - Outputs to hypothalamus, (epithalamus, subthalamus), midbrain
 - These outputs affected locomotion and orienting movements
 - The links were plastic, so habits were formed according to rewarding effects mediated, e.g., by taste effects.
 - 2) **Through the medial part of the dorsal endbrain, which became medial pallium—the hippocampal formation**
 - **Outputs to ventral striatum, hypothalamus, epithalamus**
 - **The links were plastic, but the “habits” formed were different: The association of place with good or bad consequences of approach.**

See the two major pathways from the olfactory bulb to the endbrain depicted in the next slide, taken from earlier chapter.

Evolution of corpus striatum and rest of endbrain: speculations

1. Beginnings: a link between olfactory inputs and motor control: The link becomes “Ventral striatum”. It was a modifiable link (capable of experience-induced change).

2. Non-olfactory inputs invade the striatal integrating mechanisms (*via* paleothalamic structures).

3. Early expansions of endbrain: striatal and pallial. Non-olfactory inputs to pallium [Note the two pathways going caudally from the olfactory system.]

4. Pre-mammalian & then mammalian expansions of cortex and striatum: For the striatum, the earlier outputs and inputs remain as connections with neocortex expand.

Figure 1. Postulated beginnings in primitive chordates

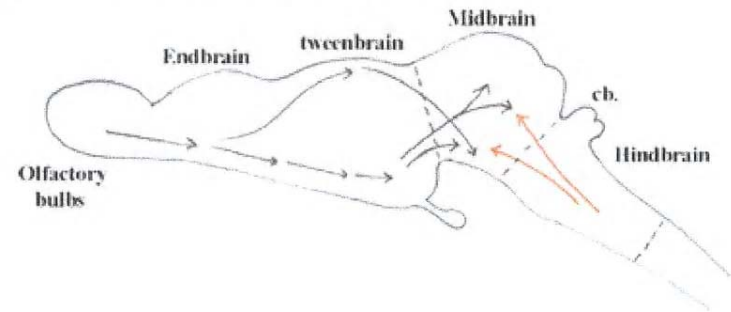

Figure 2. Other inputs reached deeper striatal layers

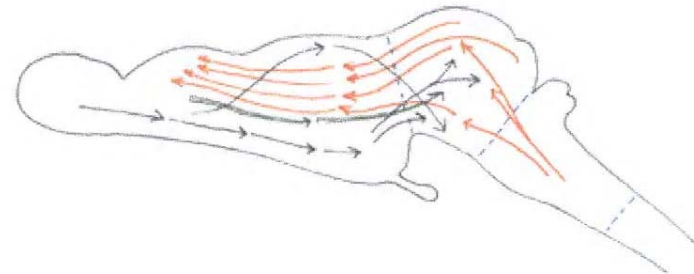

Figure 3. Early expansion of striatal and adjacent "limbic" areas

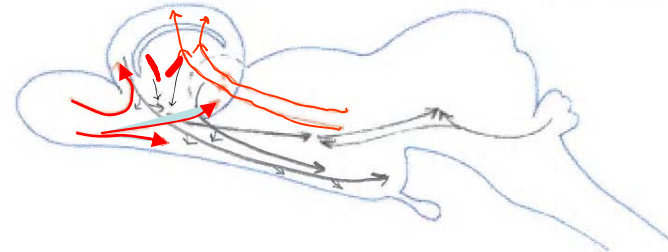
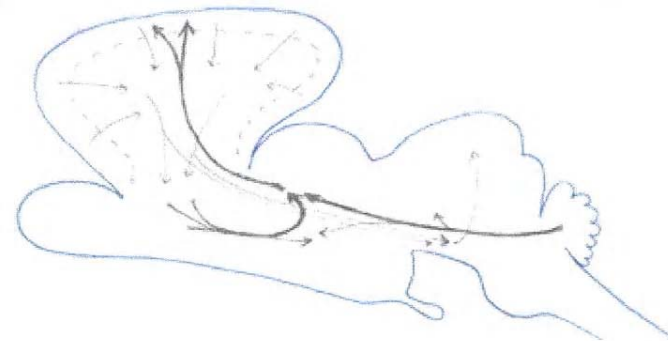

Figure 4. Pre-mammalian, and then mammalian expansions



Courtesy of MIT Press. Used with permission.

Schneider, G. E. *Brain Structure and its Origins: In the Development and in Evolution of Behavior and the Mind*. MIT Press, 2014. ISBN: 9780262026734.

Some comparative anatomy of the telencephalon: the primitive medial pallium

- Shark
- Lungfish
- Bullfrog
- A marsupial

Questions, chapter 28

- 4) What is the major change in the configuration of the medial pallium of what we call more primitive vertebrates and the hippocampus of mammals?

It became infolded in mammals: see following slides.

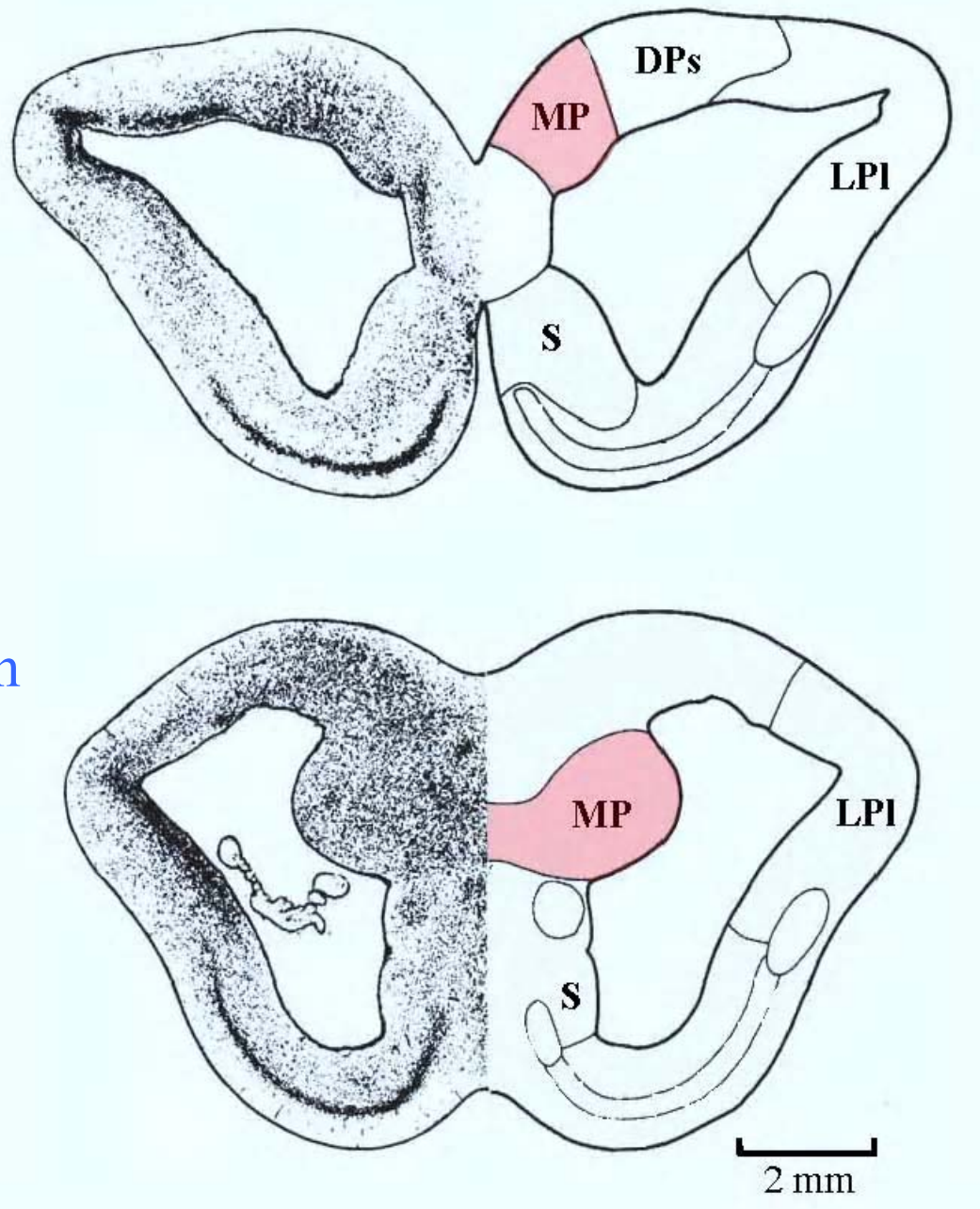

MP = medial pallium
 DP = dorsal pallium
 LP = lateral pallium
 (olfactory cortex)
 S = septal area

Fig 28-3

Endbrain of a shark: the spiny dogfish

Courtesy of MIT Press. Used with permission.

Schneider, G. E. *Brain Structure and its Origins: In the Development and in Evolution of Behavior and the Mind*. MIT Press, 2014. ISBN: 9780262026734.

Endbrain of an African lungfish

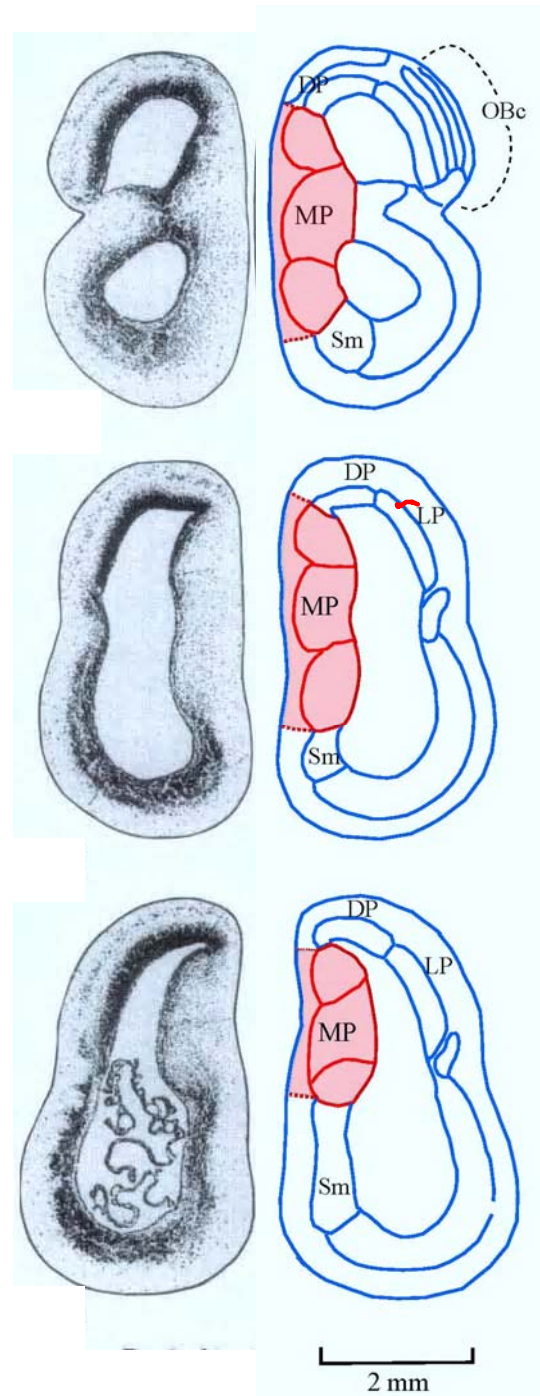
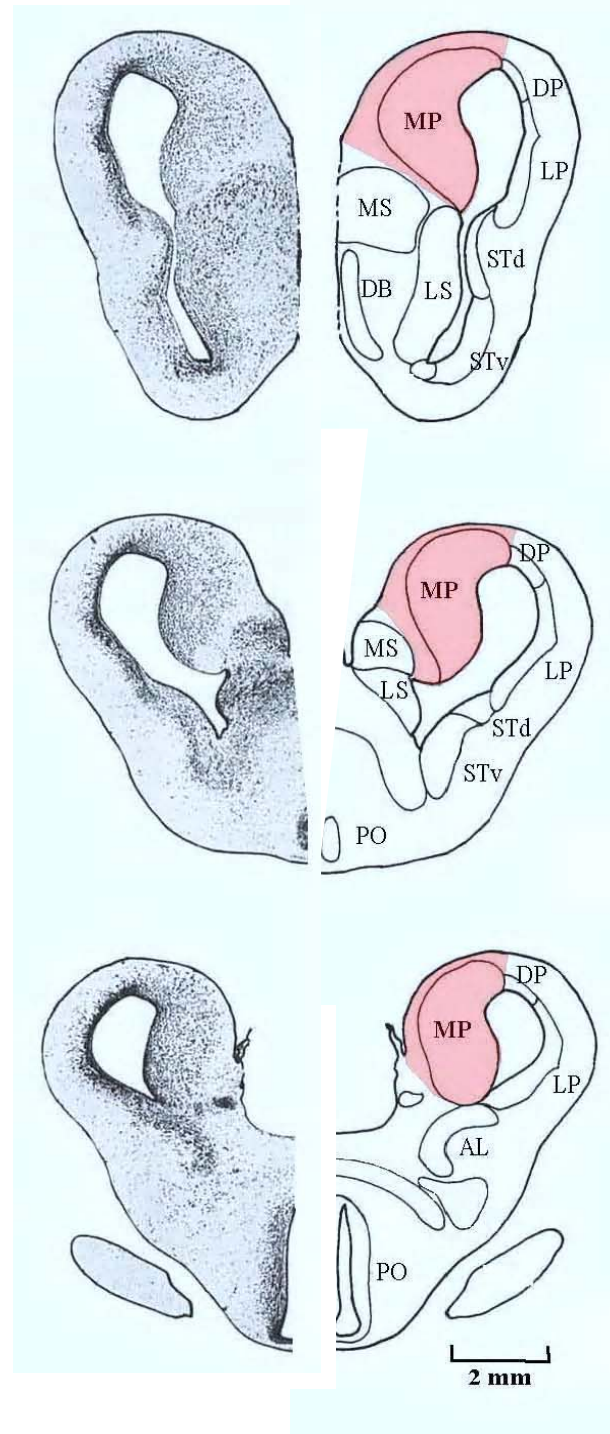

Fig 28-4

Courtesy of MIT Press. Used with permission.
Schneider, G. E. *Brain Structure and its Origins: In the Development and in Evolution of Behavior and the Mind*. MIT Press, 2014. ISBN: 9780262026734.

Endbrain of a Bullfrog



ST = striatum

Fig 28-5

Courtesy of MIT Press. Used with permission.
 Schneider, G. E. *Brain Structure and its Origins: In the Development and in Evolution of Behavior and the Mind*. MIT Press, 2014. ISBN: 9780262026734.

Figure removed due to copyright restrictions.

Please see course textbook or: Oswaldo-Cruz, E., and CjE Rocha-Miranda. "The Brain of the Opossum (*Didelphis Marsupialis*)." Instituto de Biofisica, Universidade Federal do Rio de Janeiro, 1968.

Section through the anterior end of the hippocampus (dorsal

Figure removed due to copyright restrictions.

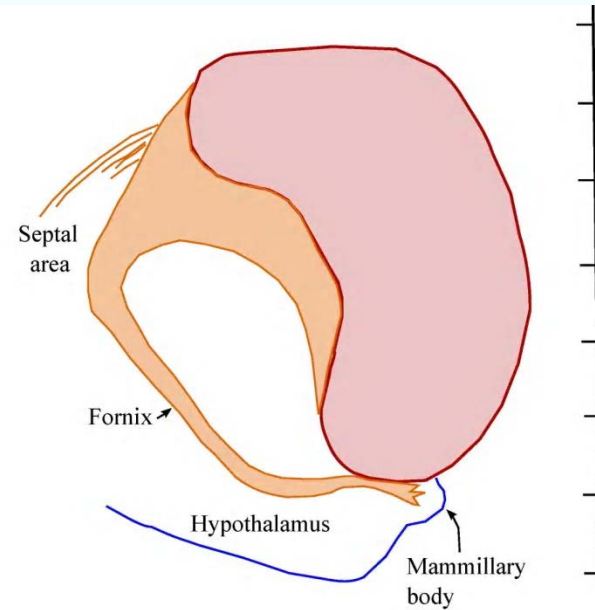
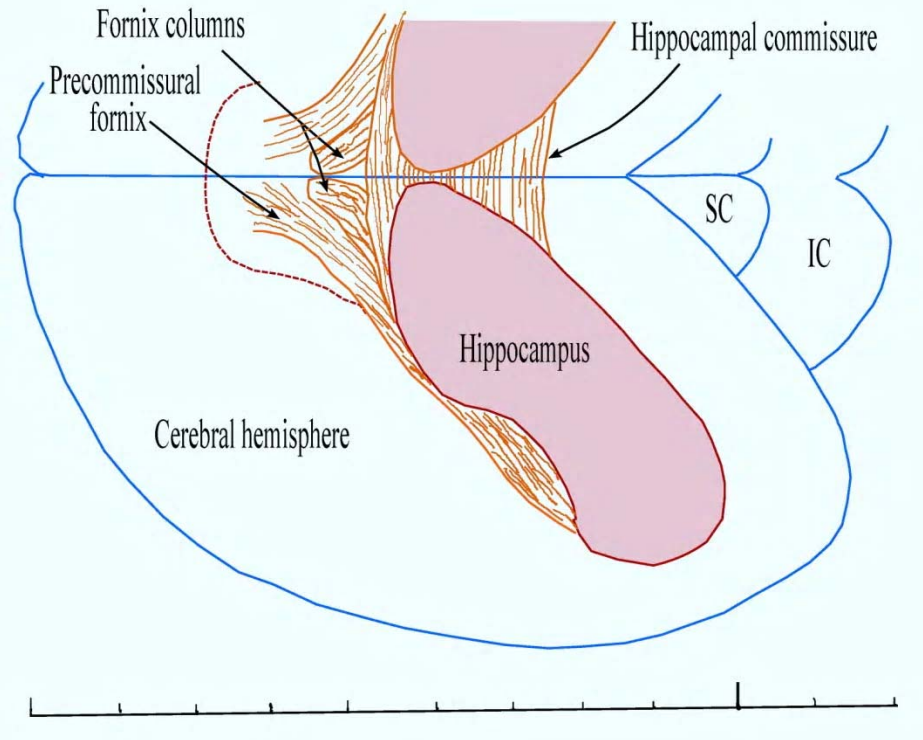
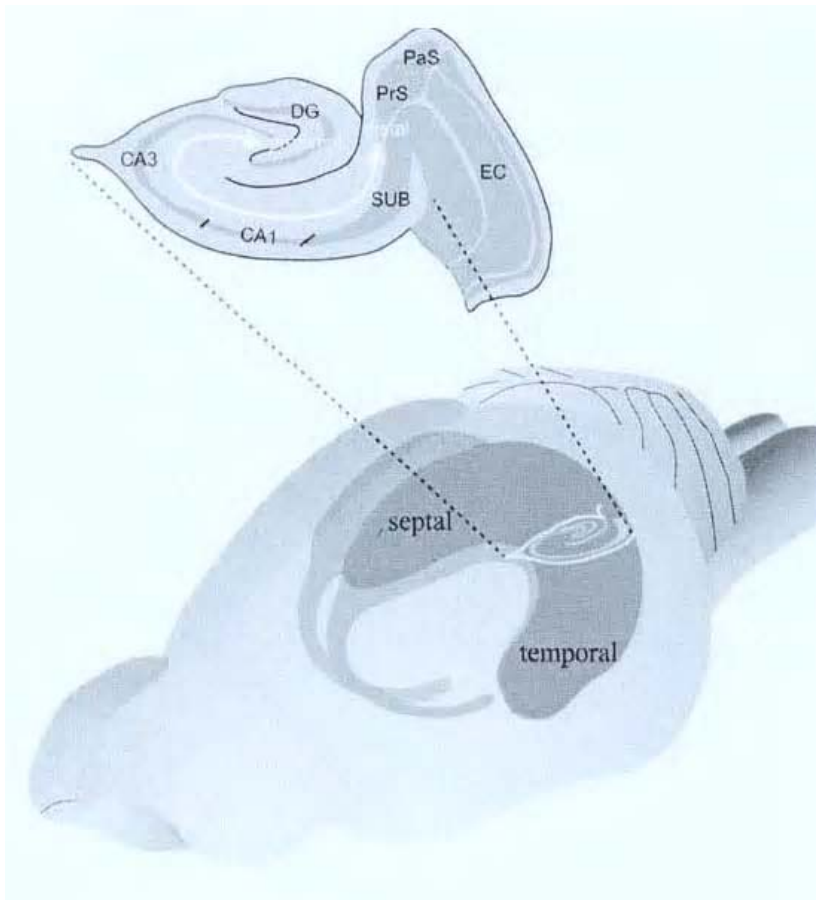

The hippocampus and its output pathway to subcortical structures in small rodents

Fig 28-8

Courtesy of MIT Press. Used with permission.
 Schneider, G. E. *Brain Structure and its Origins: In the Development and in Evolution of Behavior and the Mind*. MIT Press, 2014. ISBN: 9780262026734.

Hippocampal anatomy:

some questions to be answered

1. Identify the major sub regions of the hippocampus and adjacent structures.
2. What pattern of interconnectivity distinguishes the major portions of the hippocampus?
 - CA = Cornu Ammonis (Ammon's Horn)
 - CA1 and CA3: the two major regions
3. What is the name of the major afferent input pathway to the mammalian hippocampus and where does it originate?

following slides

11

"perforant path"

*from entorhinal cortex —
receiving major input from neocortex*

Figure removed due to copyright restrictions.
Please see course textbook or: Paxinos, George, and Charles Watson. *The Rat Brain in Stereotaxic Coordinates: Hard Cover Edition*. Academic press, 2006.

**Horizontal section of rat's hippocampus area,
stained for cell bodies**

Fig 28-7

Questions, chapter 28

- 5) What is the difference in location of the hippocampus of large primates and its location in the rat?

Medial view of human telencephalon: **Note the temporalization, with major effects on hippocampal location**

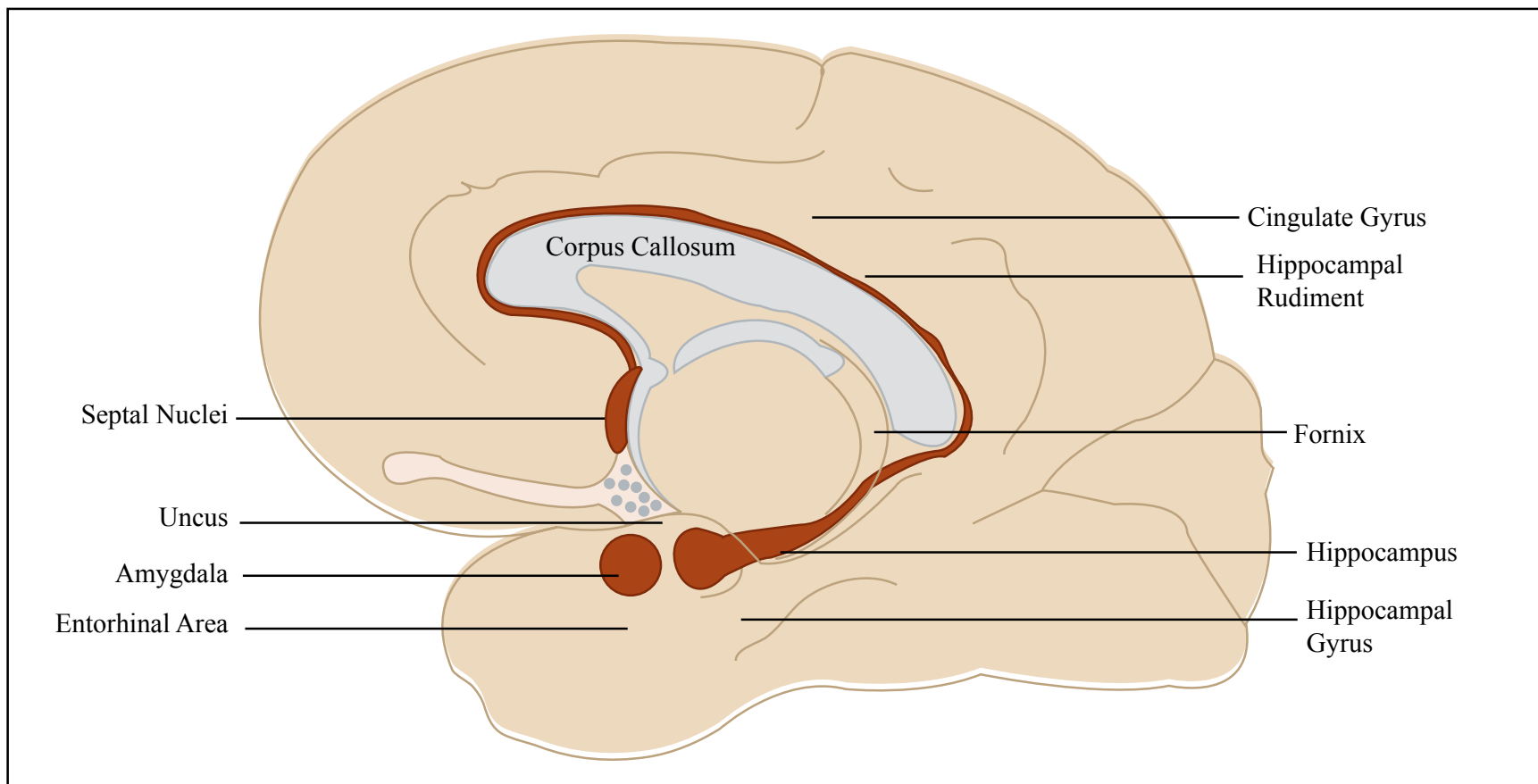
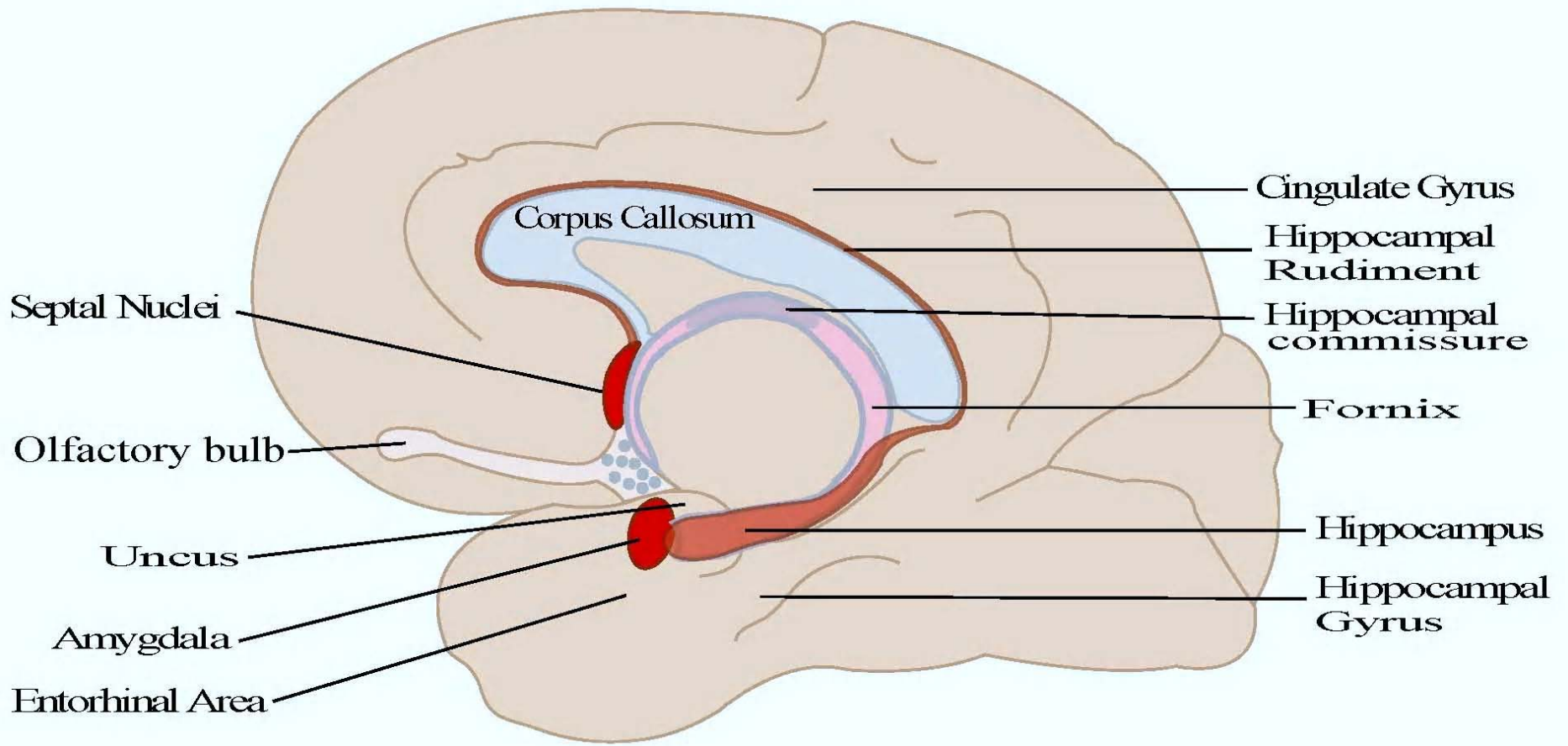

Image by MIT OpenCourseWare.

Where is the “hippocampal rudiment”? *→ next*



Courtesy of MIT Press. Used with permission.
 Schneider, G. E. *Brain Structure and its Origins: In the Development and in Evolution of Behavior and the Mind*. MIT Press, 2014. ISBN: 9780262026734.

Fig 28-9

Questions, chapter 28

- 6) In a section cut across the longitudinal axis of the hippocampus, the cell layer is subdivided by anatomists into four sectors, CA1 to CA 4, with the dentate gyrus cupped around CA4 like the hem of a skirt. What do the letters CA stand for, and where did the name come from?
- 7) Describe the circuit that begins in the entorhinal cortex and can be followed through the hippocampus to the subiculum, from which a major output to the mammillary bodies of the hypothalamus arises.
- 8) Where is long term potentiation (LTP) found in the hippocampus?

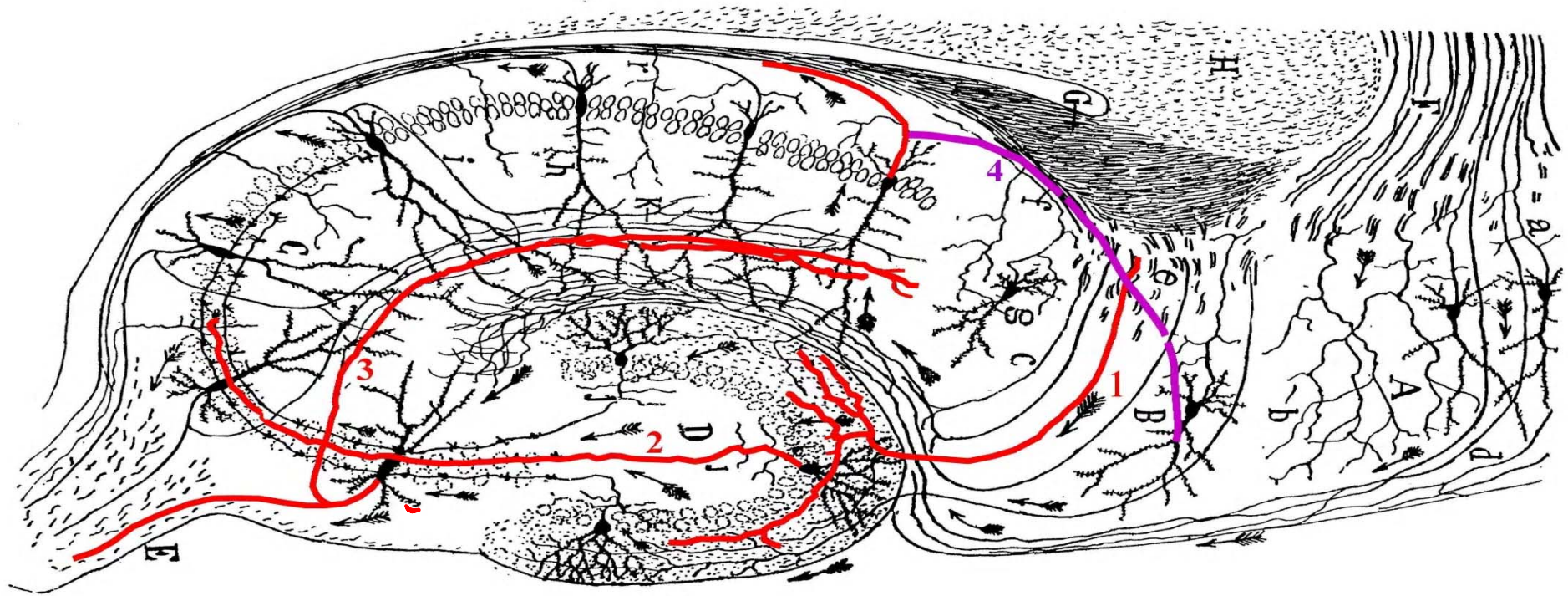

Courtesy of MIT Press. Used with permission.

Schneider, G. E. *Brain Structure and its Origins: In the Development and in Evolution of Behavior and the Mind*. MIT Press, 2014. ISBN: 9780262026734.

From entorhinal cortex to dentate gyrus to CA3 (via mossy fibers) to CA1 (via Schaffer collaterals of CA3 cell axons) to subiculum

Hippocampus:
input through the “perforant path” (axon 1), then through 3 synapses to the subiculum

Fig 28-10a

Figure removed due to copyright restrictions.

About function:

- What types of memory are dependent on the hippocampus? *spatial, declarative*
- Electrophysiology of the local circuits through the hippocampus: LTP.
- What types of memory are not dependent on the hippocampus? (On what brain areas are they dependent?)
sensorimotor habits
striatal

What is the pathway for subcortical projections to and from the hippocampus? *Fornix*

Identify a major neuromodulatory system which regulates hippocampal activity and locate the nucleus that provides this input. *Septal area, medial septal nuc.*

- > It uses acetylcholine as its neurotransmitter.

Papez' circuit brought up to date:

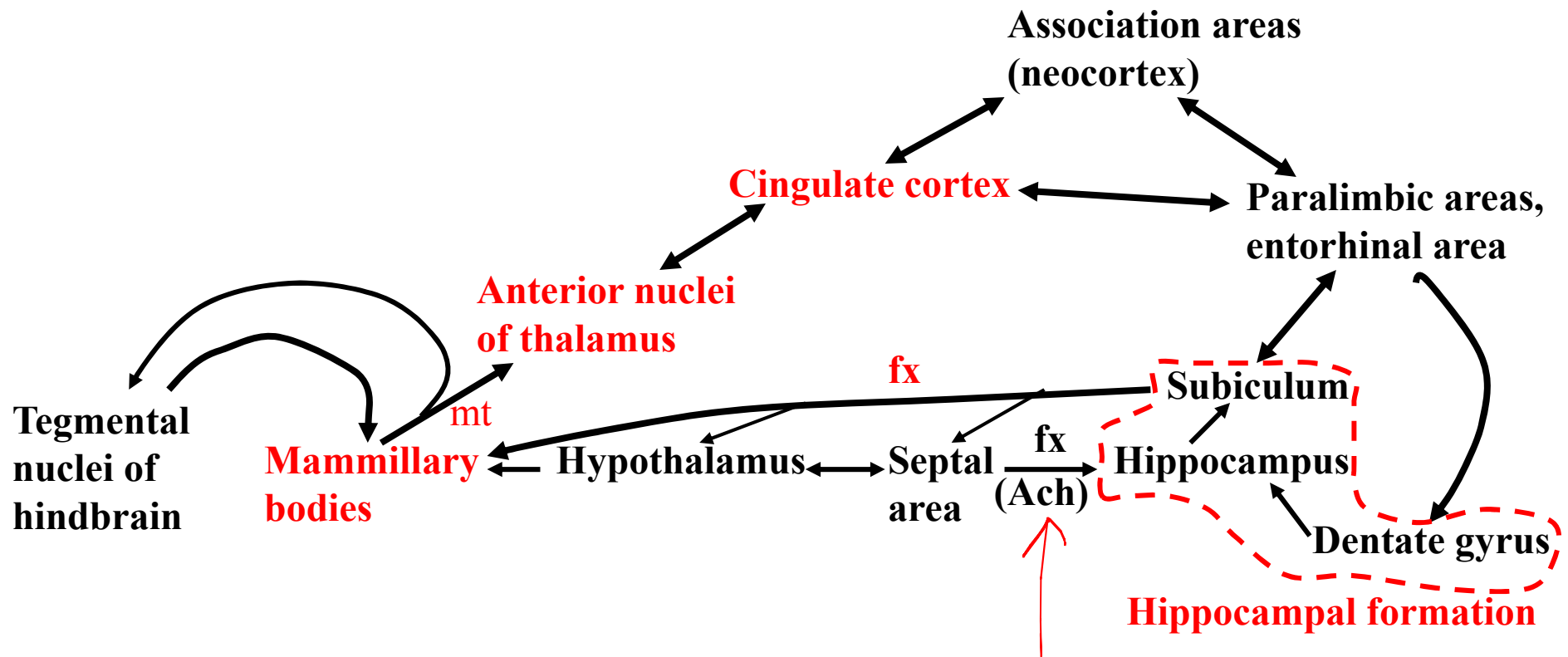

mt = mammillothalamic tract

fx = fornix bundle (output of hippocampus)

Courtesy of MIT Press. Used with permission.

Schneider, G. E. *Brain Structure and its Origins: In the Development and in Evolution of Behavior and the Mind*. MIT Press, 2014. ISBN: 9780262026734.

For comparison:
human brain, medial view of right hemisphere

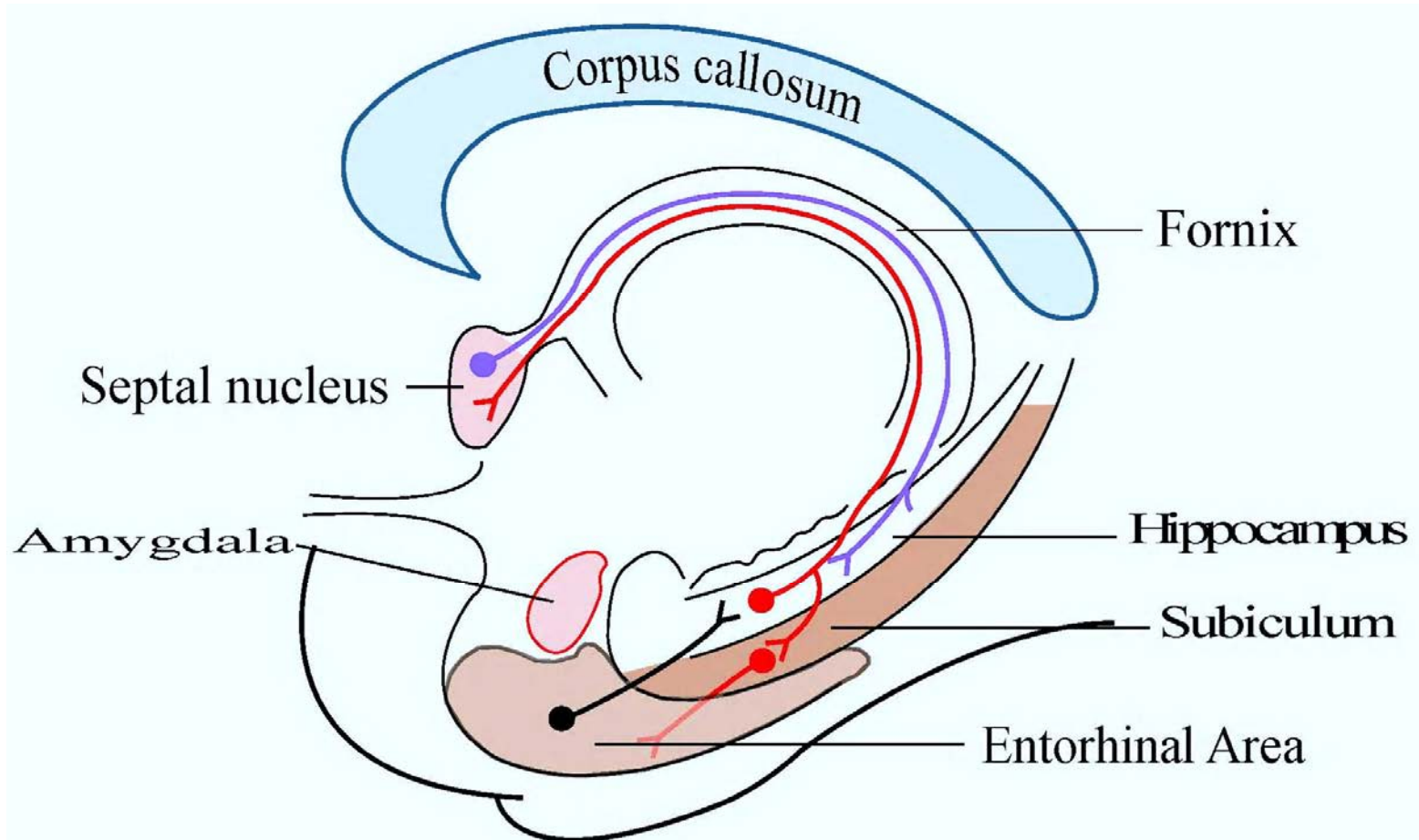

Courtesy of MIT Press. Used with permission.
Schneider, G. E. *Brain Structure and its Origins: In the Development and in Evolution of Behavior and the Mind*. MIT Press, 2014. ISBN: 9780262026734.

Fig 28-11

Questions, chapter 28

9) Describe the type of anatomical plasticity seen in the hippocampus after specific lesions in adulthood.

*collateral sprouting into
denervated areas*

Additional information:

There are 2 kinds of plasticity in the adult hippocampus

- 1) Anatomical changes after lesions
- 2) Changes during learning

We consider first the effects of lesions

Plasticity in dentate gyrus of hippocampus after entorhinal cortex lesion: Each column represents the same small slice through the dentate gyrus, with terminals of specific axonal inputs.

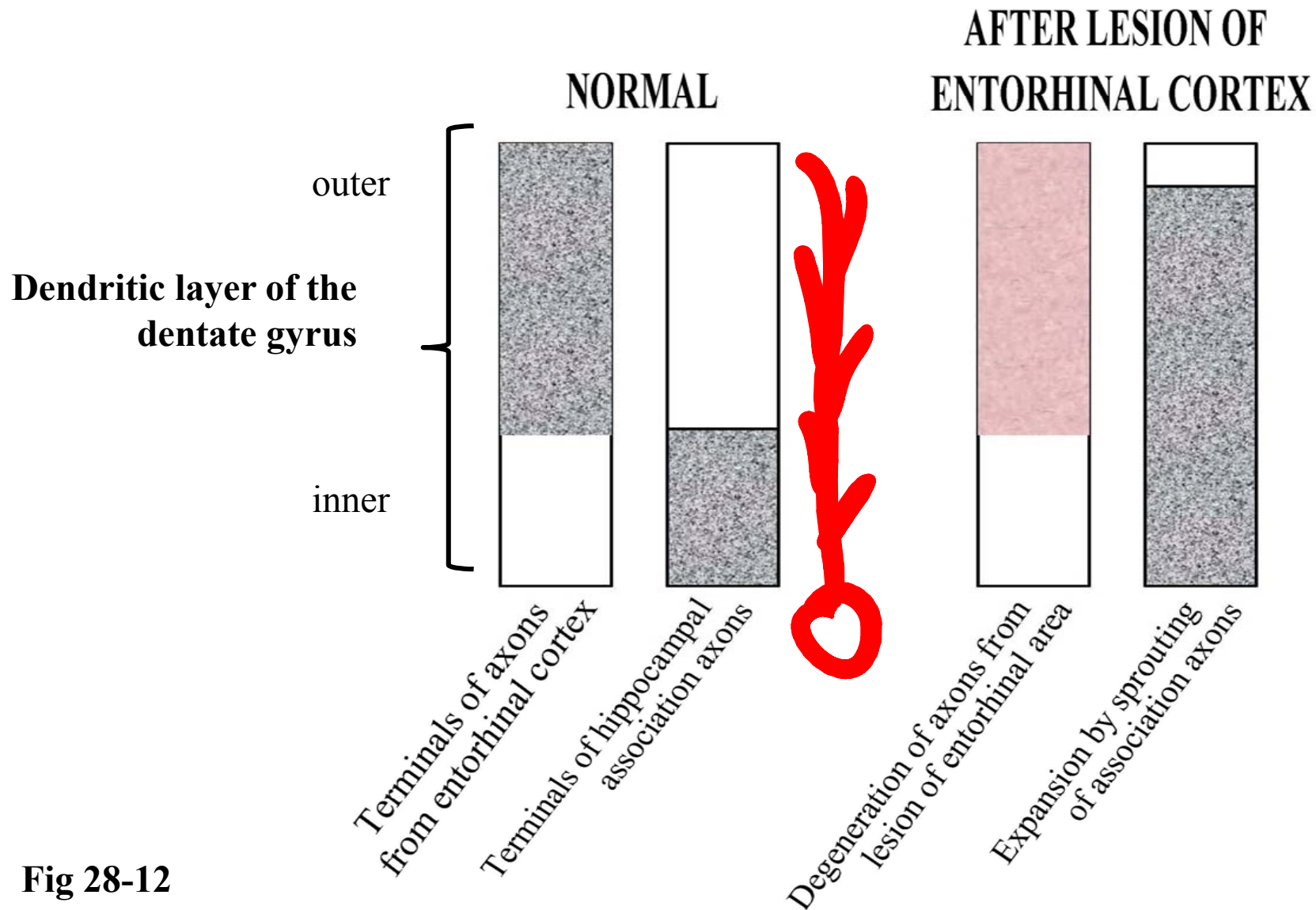

Fig 28-12

Courtesy of MIT Press. Used with permission.
 Schneider, G. E. *Brain Structure and its Origins: In the Development and in Evolution of Behavior and the Mind*. MIT Press, 2014. ISBN: 9780262026734.

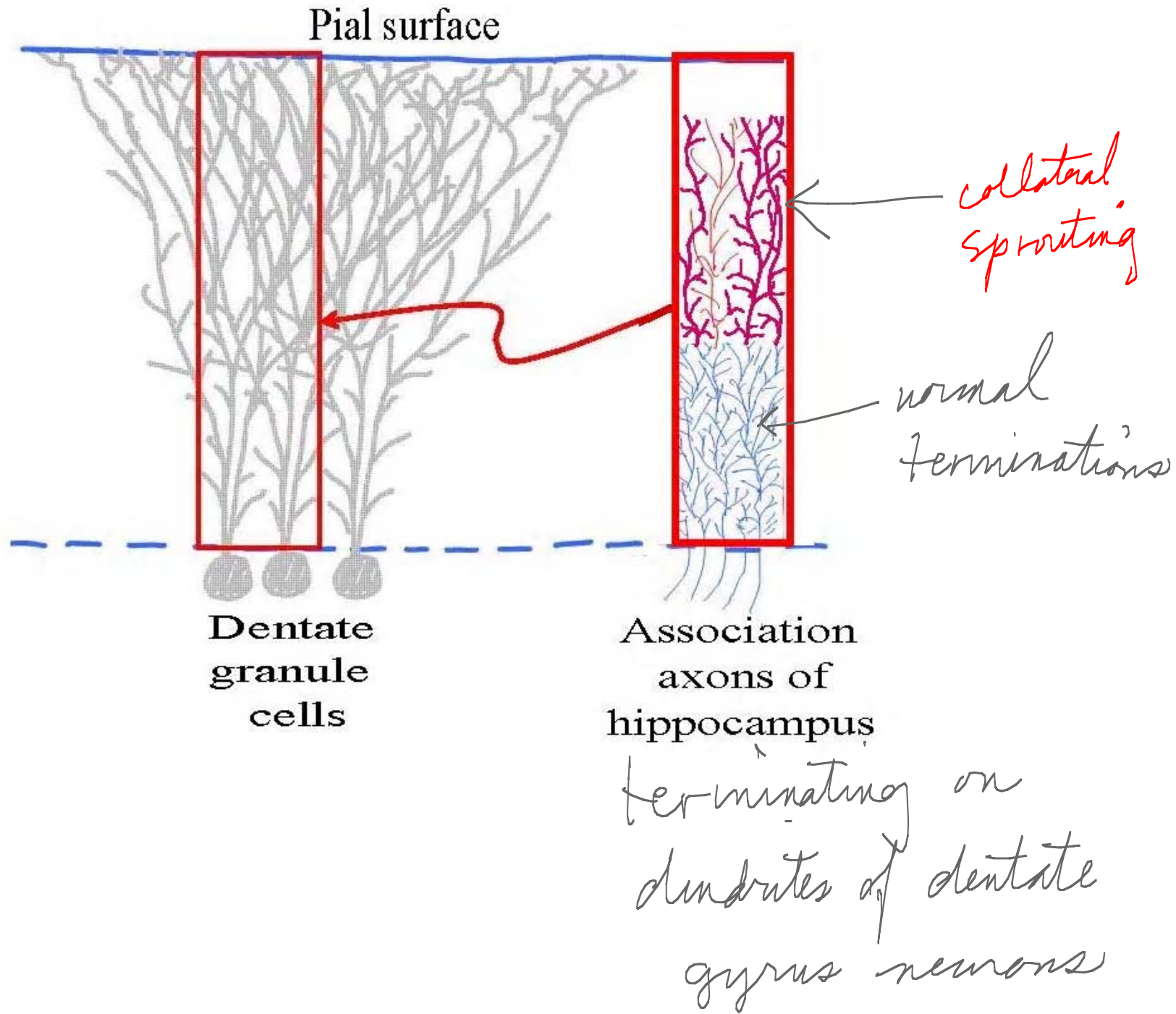

Fig 28-13

Courtesy of MIT Press. Used with permission.
 Schneider, G. E. *Brain Structure and its Origins: In the Development and in Evolution of Behavior and the Mind*. MIT Press, 2014. ISBN: 9780262026734.

Questions, chapter 28

10) How might neuromodulators affect the functioning of the hippocampus during waking and sleep?

Changes in **cortical neuromodulation** during waking, slow-wave sleep and REM sleep

Next: how is this relevant to the hippocampus and memory?

Figure removed due to copyright restrictions.

Figure removed due to copyright restrictions.
Please see course textbook or: Hasselmo, Michael E. "Neuromodulation: Acetylcholine and Memory Consolidation." *Trends in Cognitive Sciences* 3, no. 9 (1999): 351-9.

**Hippocampus during sleep & waking:
Consolidation of long-term episodic memory may be
promoted by reduced levels of ACh during slow-
wave sleep.**

Increased flow of info. from hipp.
to neocortex.

Fig 28-14

From neocortex to parahippocampal region (PHR) to hippocampal formation (HF)

PER = perirhinal cortex
 POR = postrhinal cortex

LEA = lateral entorhinal area
 MEA = medial entorhinal area

DG = dentate gyrus
 Sub = subiculum

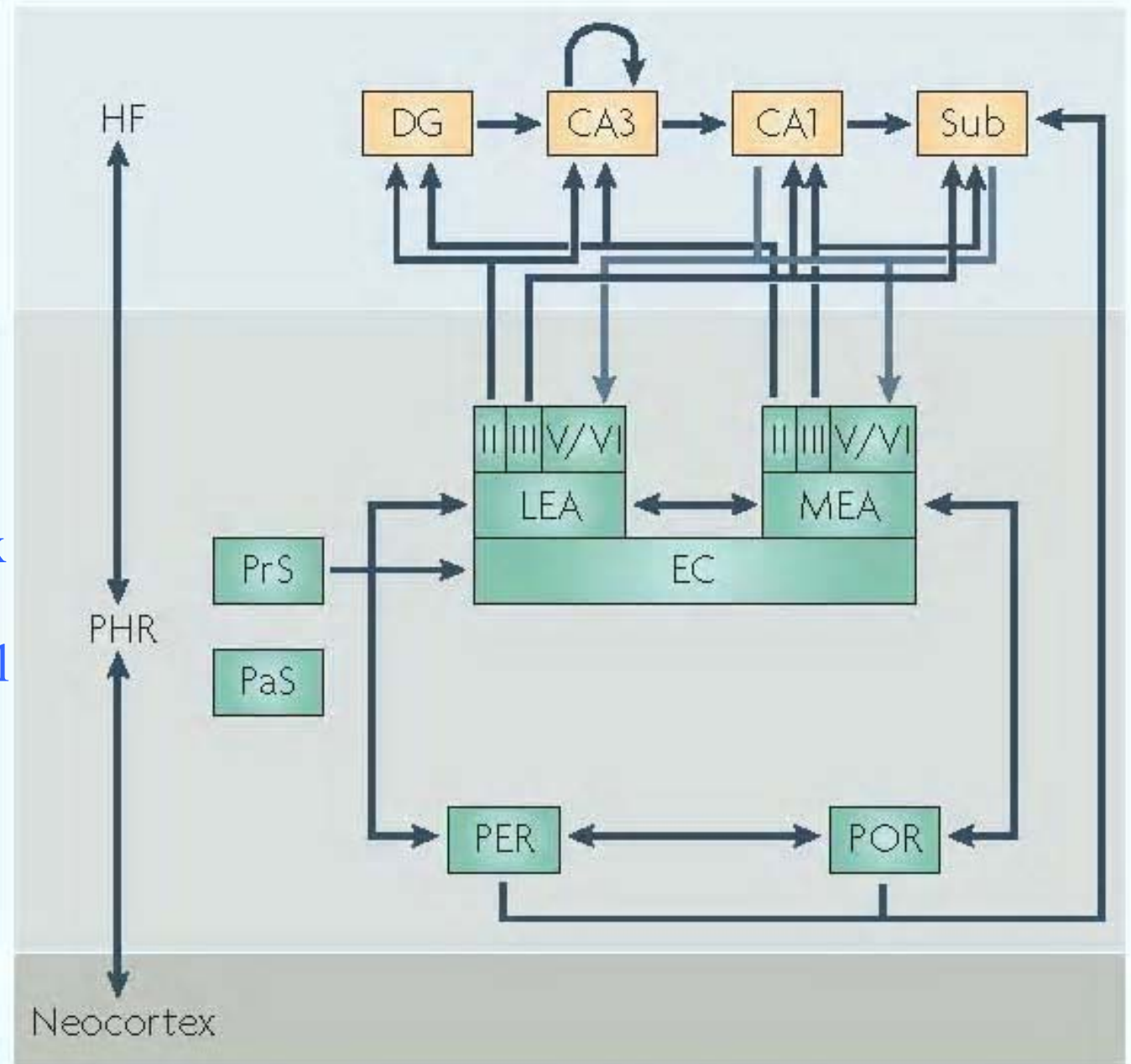

Fig 28-10b

Reprinted by permission from Macmillan Publishers Ltd: Nature Reviews Neuroscience. Source: Van Strien, N. M., N. L. M. Cappaert, et al. "The Anatomy of Memory: An Interactive Overview of the Parahippocampal-Hippocampal Network." *Nature Reviews Neuroscience* 10, no. 4 (2009): 272-82. © 2009.

Questions, chapter 28

11) Why is the neocortex of critical importance in the function of the hippocampus in mammals?

It is the origin of the major input that reaches the hippocampal formation through the entorhinal cortex and other paralimbic cortical areas.

"It" means primarily multimodal association areas.

It is also a major recipient of information retained in hippocampal circuitry during memory formation--the information is transferred to neocortex during memory consolidation.

Additional pictures of human brain

**Human
hippocampus,
fornix,
amygdala
(*Nolte*)**

Figure removed due to copyright restrictions.

Human hippocampal formation in Nissl-stained section (*Brodal 20.10*)

Figure removed due to copyright restrictions.

Please see figure 20.10 of: Brodal, Per. *The Central Nervous System, Structure and Function*. 3rd ed. Oxford University Press, 2003. ISBN: 9780195165609.

The human hippocampal formation, fornix, mammillary nucleus, and the amygdala. In the upper picture they are seen obliquely from behind. In the lower picture they are seen from above.

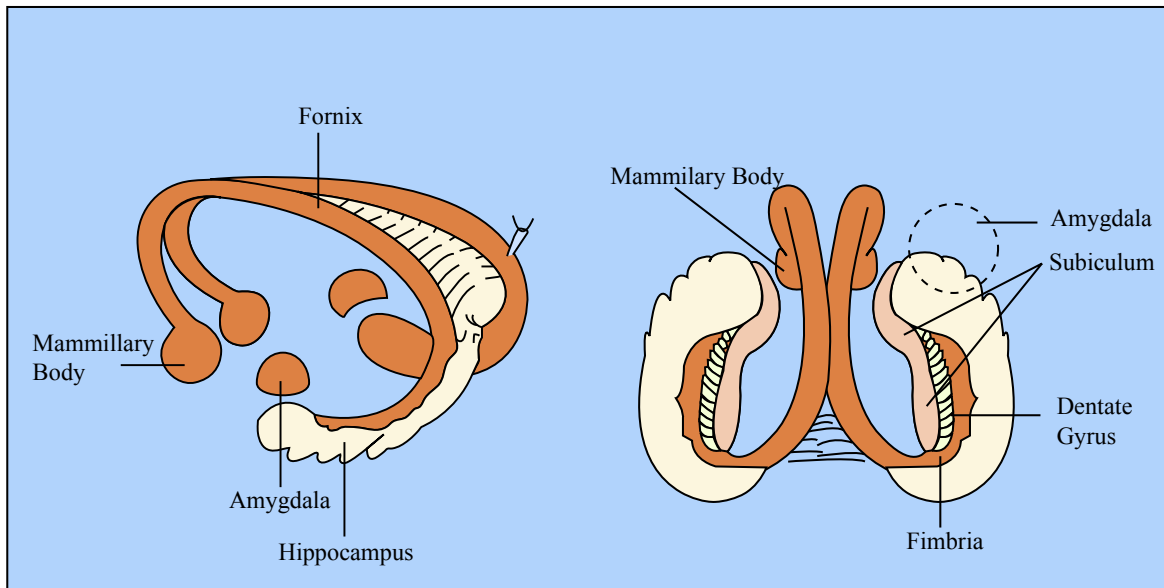
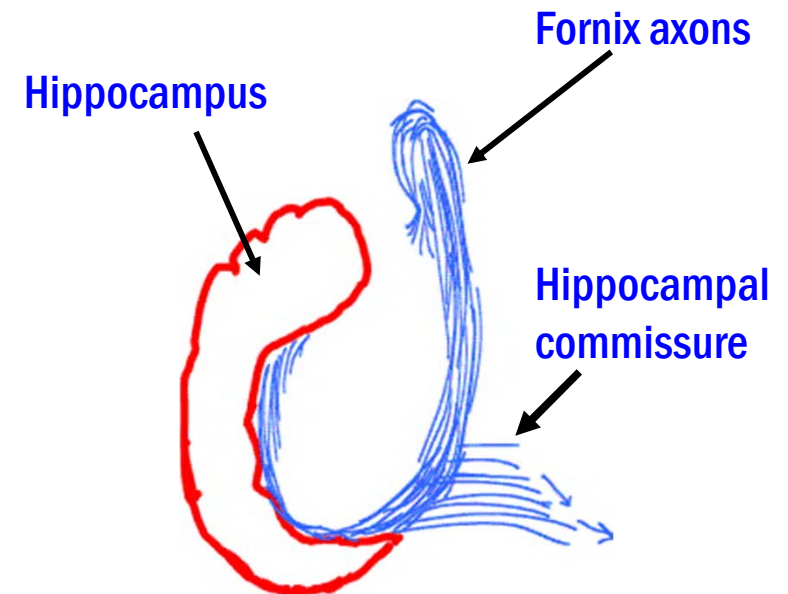

Image by MIT OpenCourseWare.



Brodal 20.12

Figure removed due to copyright restrictions.

Please see figure 20.11 of: Brodal, Per. *The Central Nervous System, Structure and Function*. 3rd ed. Oxford University Press, 2003. ISBN: 9780195165609.

(Omits projection from
subiculum to the
mammillary body in
the hypothalamus)

Structure of human hippocampus

(Nolte textbook)

Figure removed due to copyright restrictions.

Human MRIs showing hippocampus and amygdala (*Brodal 20.11*)

Figure removed due to copyright restrictions.

Please see figure 20.11 of: Brodal, Per. *The Central Nervous System, Structure and Function*. 3rd ed. Oxford University Press, 2003. ISBN: 9780195165609.

MIT OpenCourseWare
<http://ocw.mit.edu>

9.14 Brain Structure and Its Origins

Spring 2014

For information about citing these materials or our Terms of Use, visit: <http://ocw.mit.edu/terms>.