

16.886 - Air Transportation Systems Architecting

Course Introduction

(Image removed due to copyright considerations.)

February 3, 2004
Prof. Earll Murman

Course Information

16.886 Air Transportation Systems Architecting

Graduate (Spring) H-Level Grad Credit

Prereq: 16.885 or permission of instructor

Units: 3-2-7

Lecture: TR9.30-11 AM Lab: Wed 3-5 pm

Faculty: Earl Murman, John-Paul Clarke, John Hansman

Bob Liebeck, Al Haggerty, Guest lecturers

Accounts will be set up on workstations

Agenda

- Drivers - Commercial and Military Cargo Transport Needs
- Responses - Conventional and Advanced Concepts
- Formation Flight - A Possible Approach
 - Basic concepts
 - One flight result
 - Other considerations
- Plan for the semester
- Questions and responses
 - Turn in Student Profile and Preferences at end of class

Commercial Drivers

- Globalization trends
 - Longer distances between producers and consumers
 - Emerging markets, e.g. China, South America, Africa
- Lean manufacturing
 - Focus on “flow” to eliminate waste, e.g. JIT
 - Faster response to market demands
- Air freight operators looking for new markets
 - Most transoceanic freight shipped by surface
 - Gap in capability- “middle market”
 - Ship is inexpensive but takes 18-30 days
 - Air is expensive but takes only 3-6 days
- Operating economics drive
 - Increased capacity per air freighter
 - Reduced crew and fuel costs

Commercial Trends

- Bartowski (FedEx) “Future Concepts for Air Cargo Delivery”, AIAA Paper 2003-2629
 - Freighter fleet expected to double in 20 years
 - 90% of fleet capacity in “wide-body” aircraft in 20 years leading to 23% growth in payload capacity
 - Growth is in the “middle market” between air and surface for world wide freight market.
- Jiang, et al (MIT ICAT), “Market and Infrastructure Analysis of Future Air Cargo Demand in China”
 - Air cargo growth through China airports expected to grow at 11.2% per annum for next 20 years. Includes both domestic and import/export.

Commercial Trends - Cont'd

- Allison, et al “Expedited Transport Airlines”, Final Report for 16.899 Air Transportation System Architecting.
 - World air cargo and freight to grow at 6.4-6.5% per year for next 10 years.
 - Total worldwide freight shipping expected to go from 132 to 383 Freight-Ton-Kilometers in 20 years.
 - Freighter Fleet to grow from 1,775 to 3,078, including retirement of 1,228 old freighters, mostly narrow body.
 - Long range freighter segment will be the fastest growing
 - Standard shipments take 4-6 days with only 10-15% time in the air. Most the time is ground transport, handling, waiting.
 - Top 10 markets will generate 40% of global airfreight in next 10 years: Intra Asia, China ⇒ Europe, China ⇒ North America, North America ⇔ Asia, Europe ⇔ Asia, North America ⇔ Europe, Domestic USA

Lots of good data in this report from last year's class.

Military Drivers

- Threats are global
- Reaction times are shorter
- Trends are towards US basing for security, economic and political factors
- Result is US forces are becoming more expeditionary
- Rumsfeld's Transformation goals for Army
 - Deploy 1 division anywhere in the world in 5 days
 - Deploy 5 divisions anywhere in the world in 30 days
 - Division is 16,000 personnel and all their equipment
- Long range bombers based on continental US require considerable tanker support which is expensive and logistically complicated.

We need more information on military drivers

Summary of Drivers

- Both commercial and military
 - Need more weight and volume transported over long distances.
 - Mostly intercontinental
 - Need “block times” in days rather than weeks
 - Ground transport and handling is important
 - Focus on integrated system, not just aircraft
 - Need affordable costs
 - More expensive than surface but less expensive than current air

Blended Wing Body



Courtesy of Boeing Corporation. Used with permission.

- Principles - Low wetted area, span loading, composites, modular layout
- Metrics for FedEx study*
 - TOGW 1,350,000 lb
 - Payload 525,000 lb
 - Range 5000 nm
 - Volume 51,000 ft³
 - 62 % payload and 15% DOC advantage over A380
- Limitations - Still a “paper” airplane. No showstoppers.

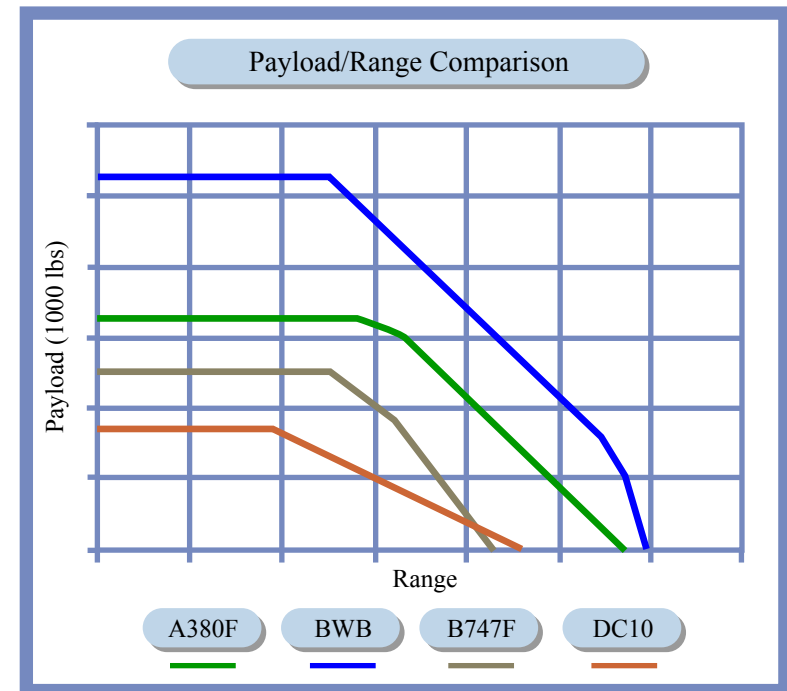

* Barkowski, R, “Future Concepts for Air Cargo Delivery”, AIAA Paper 2003-2629. Also see Wakayama, S, Gilmore, R., Brown, D., “Design Trades for a Large Blended-Wing-Body Freighter”, AIAA Paper 2003-2503

Wing In Ground Effect

King, A and Gopalarathnam

- Principles - Interference with ground reduces induced drag substantially for very small spacings
- Metrics for Pelican*
 - 500 foot wing span
 - 38 fuselage mounted landing gears similar to B-52
 - Payload 1,500,000 lbs
 - Range
 - 10,000 nm over water
 - 6,000 nm over land @ 20,000 ft
- Limitations: Many technology and operational issues

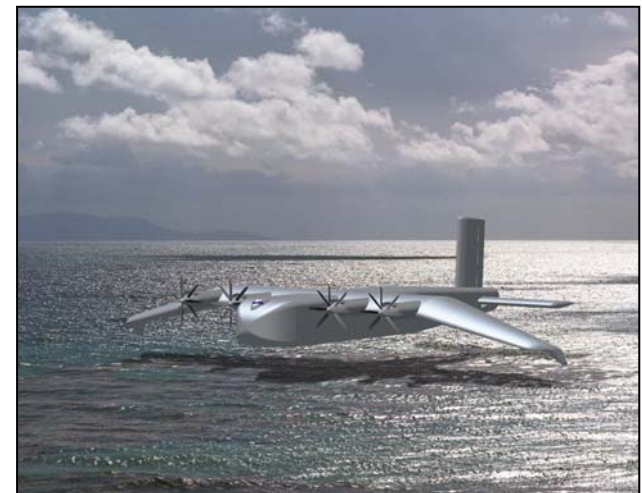
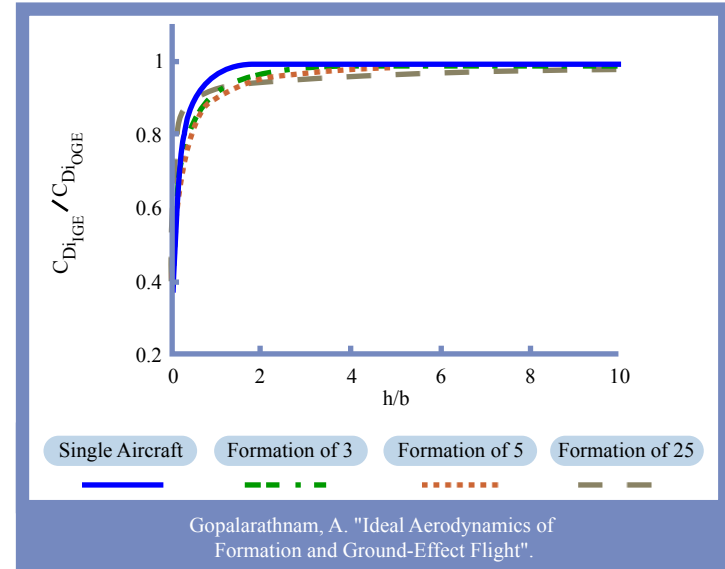

Boeing Phantom Works Pelican
Courtesy of Boeing Corporation. Used with permission.

* Barkowski, R, "Future Concepts for Air Cargo Delivery", AIAA Paper 2003-2629

Formation Flight - Nature's Solution

(Image removed due to copyright considerations.)

- Principles
 - Favorable aerodynamic interference
 - 1970 paper by Lissaman and Shollenberger
 - Est 71% increase in range, 24 % reduction in V for 25 birds
 - Modular approach to scaling
- Status
 - Aerodynamic theory reasonably well developed
 - Flight tests have demonstrated 12-18% less fuel burn for 2 aircraft formations.
 - Frequently used for military maneuvers
 - Close aircraft spacing increases pilot workload
 - Suggest autonomous or semi autonomous system
- Little exploration into long-haul applications and systems issues.

Aerodynamic Basics of Formation Flying* - I

- Consider a formation of different wings μ with geometric parameters
 - b_μ , AR_μ , S_μ , etc
- Formation geometry remains fixed - speed V is the same for all wings.
- Level flight $L_\mu = W_\mu$
- Let subscript 0 be wing μ isolated, w/o formation

$$L_{\mu 0} = W_\mu = L_\mu$$

$$\text{Power} = N_{\mu 0} = D_{\mu 0} V$$

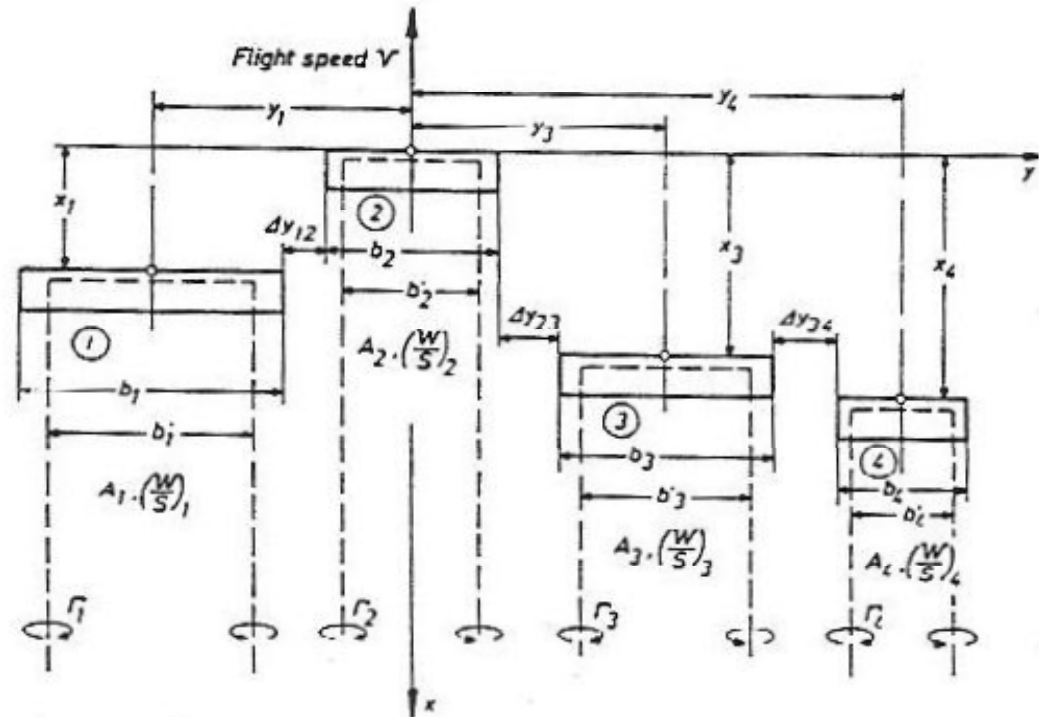

Each wing flies in the downwash field of all the other wings, represented here as horseshoe vortices with span $b'_\mu = \frac{\pi}{4} b_\mu$

* Hummel, "The Use of Aircraft Wakes to Achieve Power Reductions in Formation Flight", AGARD CP-584, May 1966

Aerodynamic Basics of Formation Flying* - II

Let the average downwash at wing μ be \bar{w}_μ

Drag reduction for wing μ ; $\Delta D_\mu = L_\mu \frac{\bar{w}_\mu}{V} = L_{\mu 0} \frac{\bar{w}_\mu}{V}$

Power reduction; $\Delta N_\mu = \Delta D_\mu \cdot V = L_{\mu 0} \cdot \bar{w}_\mu$

Relative power reduction; $e_\mu = \frac{\Delta N_\mu}{N_{0\mu}} = \frac{L_{\mu 0} \cdot \bar{w}_\mu}{D_{0\mu} \cdot V}$

For the formation; $\Delta N = \sum_{\mu=1}^n \Delta N_\mu$. And for all the wings w/o formation flight; $N_0 = \sum_{\mu=1}^n N_{0\mu}$

Relative power reduction for the formation; $E = \frac{\Delta N}{N_0}$

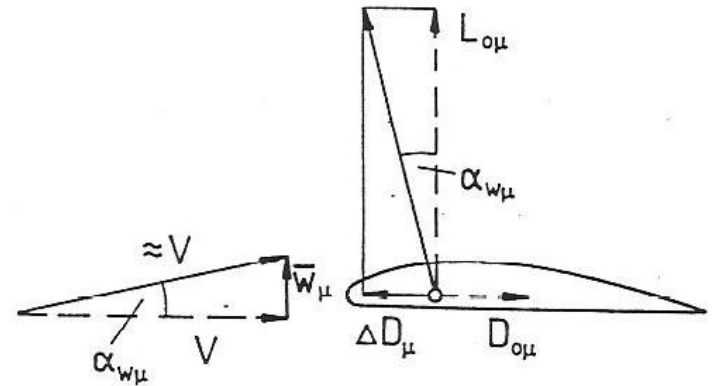

* Hummel, "The Use of Aircraft Wakes to Achieve Power Reductions in Formation Flight", AGARD CP-584, May 1966

Aerodynamic Basics of Formation Flying*-III

- Total power reduction of formation of equal size wings as a function of lateral spacing between the wings.
- No vertical separation between wings.
- Parasite drag assumed equal to induced drag, i.e. maximum range conditions
- Total power reduction 10-20% or more based upon simple model.
- Munk's stagger theorem says that total power reduction does not depend upon streamwise spacing of wings.

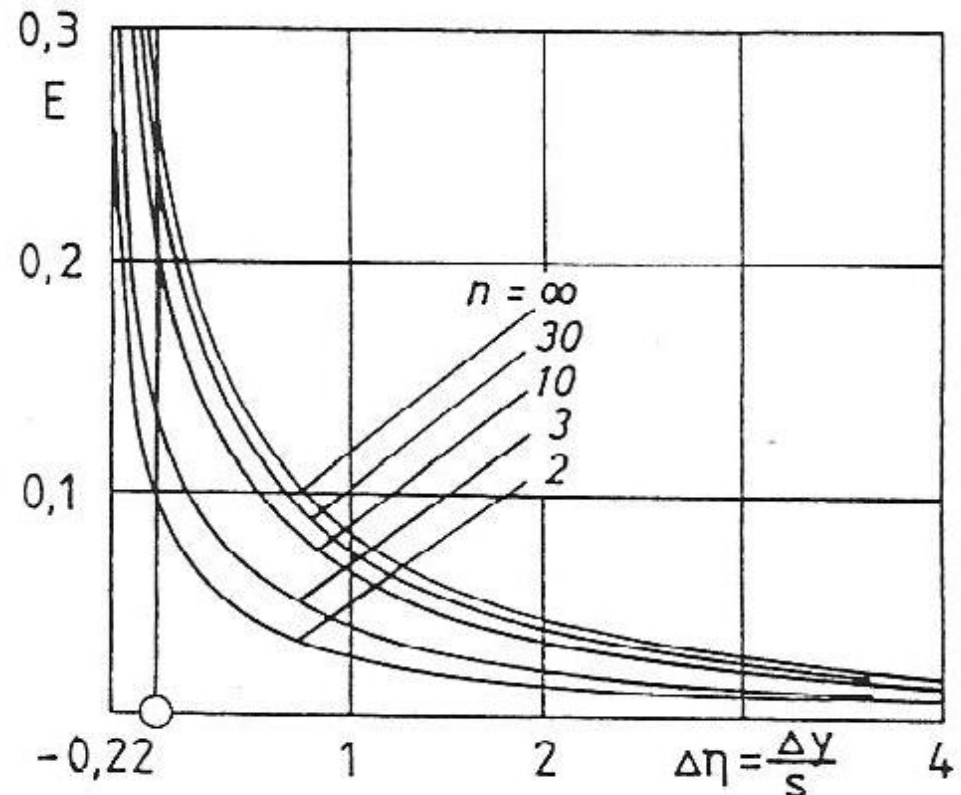

* Hummel, "The Use of Aircraft Wakes to Achieve Power Reductions in Formation Flight", AGARD CP-584, May 1966

Aerodynamic Basics of Formation Flying*-IV

- Three different arrangements of 15 wings swept 45° with zero spanwise separation
- All have the same total power reduction
- Distribution of power reduction among the wings is different for the three formations
- Formation A is called a Chevron
- Formations B, C called a "V"
- This is just one example of the many various formation geometries possible

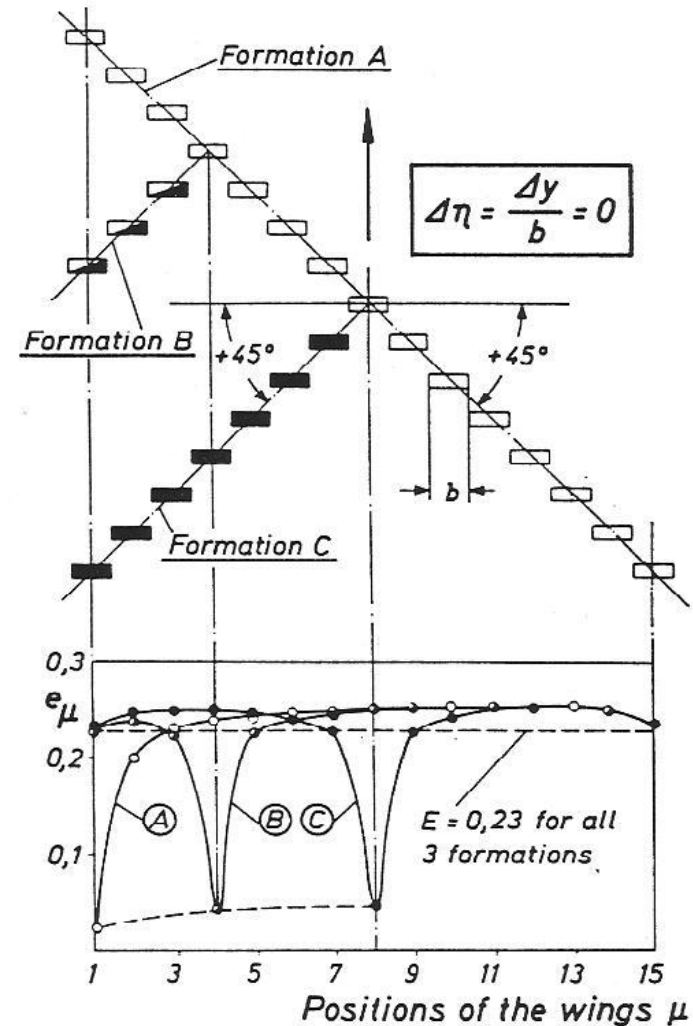

* Hummel, "The Use of Aircraft Wakes to Achieve Power Reductions in Formation Flight", AGARD CP-584, May 1966

Aerodynamic Basics of Formation Flying*-V

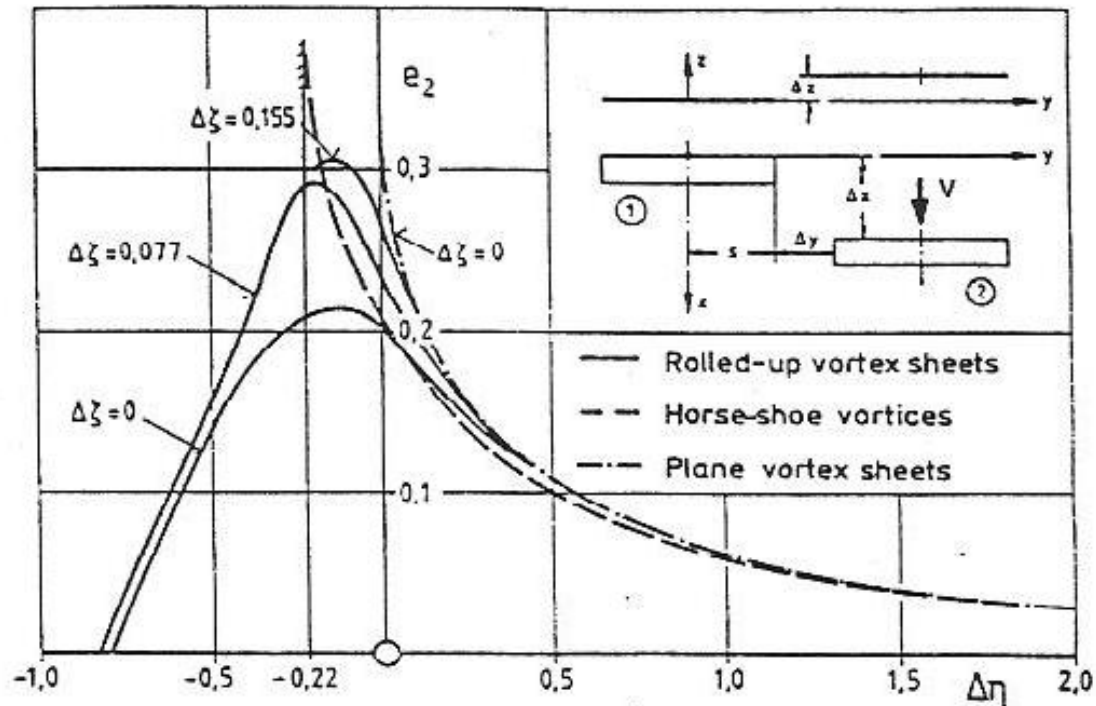

- More elaborate vortex wake models agree well with simple horseshoe model for two wings and span separations greater than approx 0.25
 - Trends are ok even for smaller span separations
 - Three rolled up sheet results are for three different vertical separations
- Deductions: Want small lateral separations, some vertical separation

* Hummel, "The Use of Aircraft Wakes to Achieve Power Reductions in Formation Flight", AGARD CP-584, May 1966

Flight Tests*

- Streamwise spacing kept same by flight velocity
- Trail aircraft autopilot used a “minimum power” approach.
- Aileron angles and measured upwash in symmetry plane used as inputs to autopilot
- Measured energy reductions comparable with theory
- Lots of scatter

$$c_{L2} = 0,87$$

$$c_{L2}/c_{L1} = 0,71$$

$$\Delta \xi = 6,0$$

$$\Delta \eta = 0$$

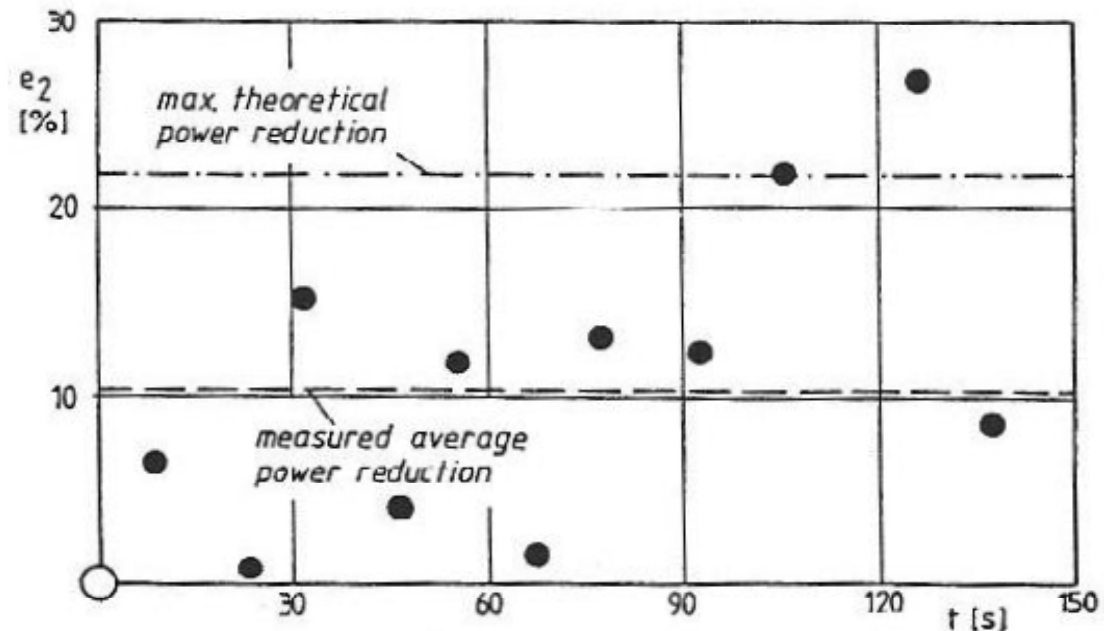
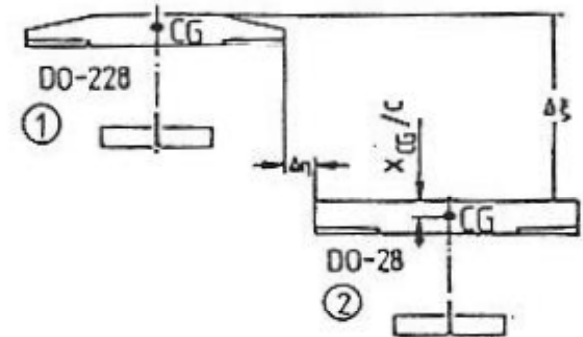

* Hummel, “The Use of Aircraft Wakes to Achieve Power Reductions in Formation Flight”, AGARD CP-584, May 1966

Variations on the Theme - I*

- Consider distribution of lift among aircraft such that the total formation induced drag is minimized.
- “Total [induced] drag is minimized with an elliptical distribution of weight across the formation”
- Other interesting results in paper about practical implementation for chevron formation
- Paper has nice formulation of horseshoe vortex model.

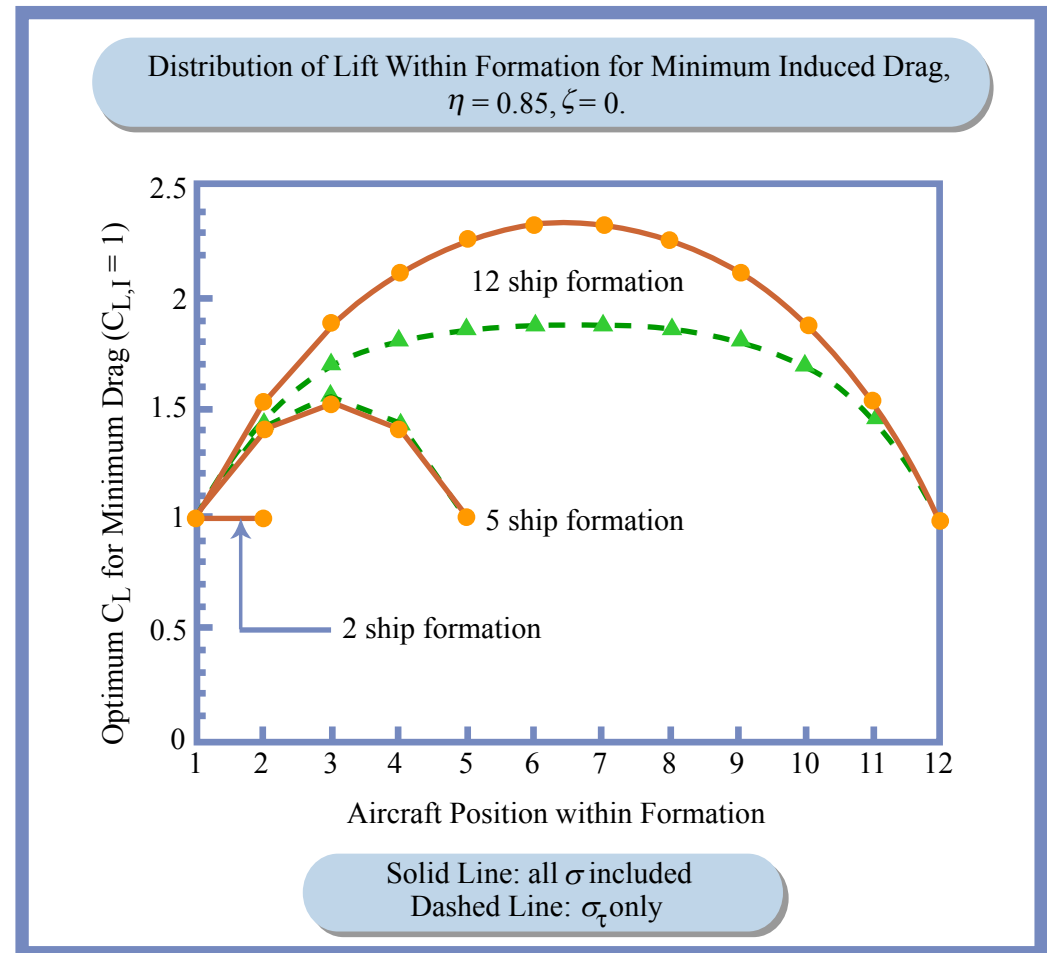

* Blake and Multhopp, “Design, Performance and Modeling Considerations For Close Formation Flight”, AIAA 98-4343

Variations on the Theme - II*

- Considers both formation and ground effects
- Calculated formation shape yielding equal induced drag for each aircraft.
- Near the tip of the “V” the wings are more abreast than near the back
 - Agrees with Lissaman and Shollenberger
- Not much influence of ground effect on formation geometry

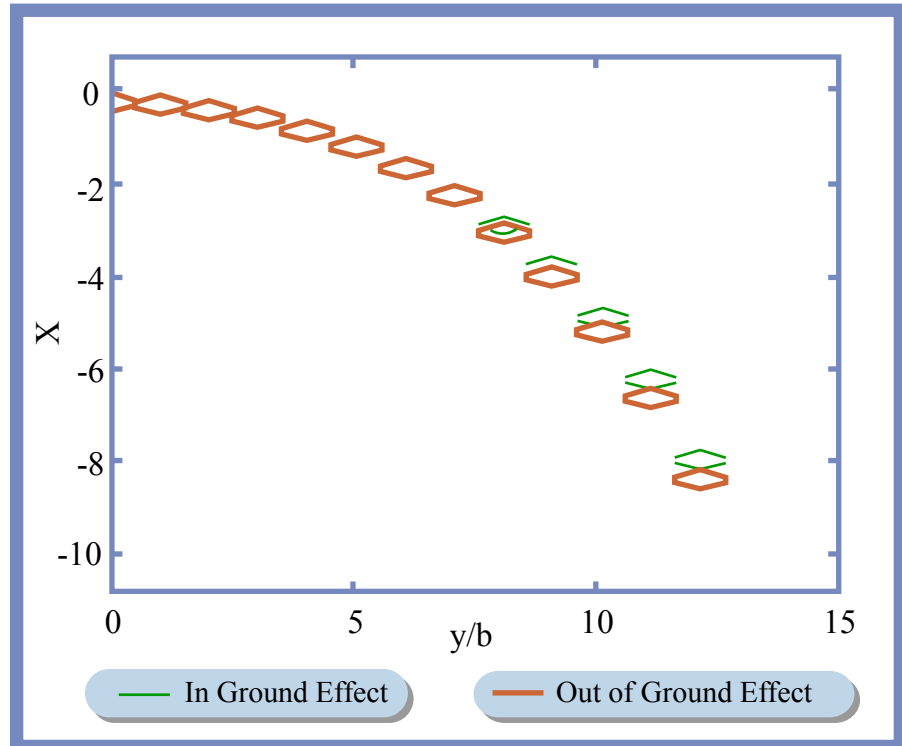

* King, A and Gopalarathnam, A, “Ideal Aerodynamics of Ground-Effect and Formation Flight

Variations on the Theme - II*

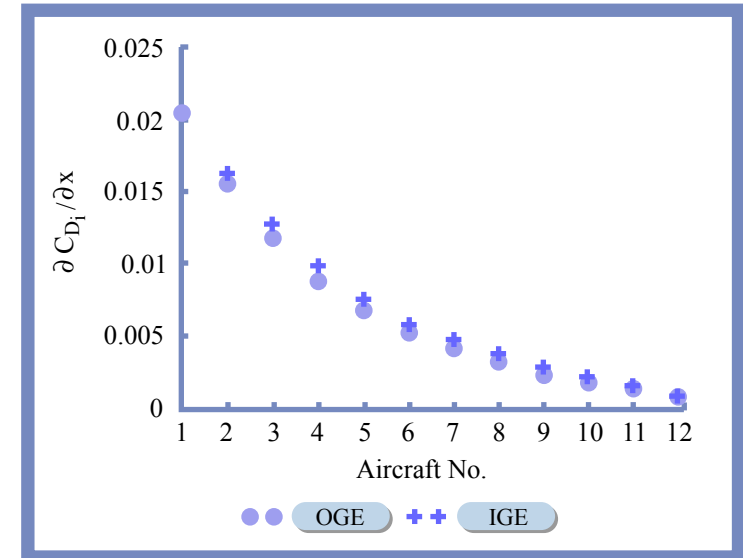
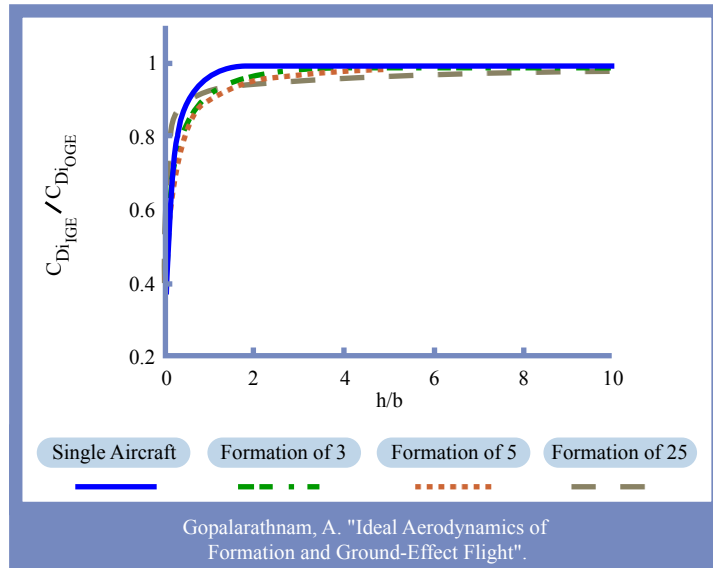

- Significant ground effect only for small heights above ground.
- Formation effects improve ground effect for larger heights

- Swarm is naturally stable. If an aircraft moves ahead of the flock it takes more power and if it moves aft it takes less
- Stability diminishes at tip. Aircraft more likely to “wander”

* King, A and Gopalarathnam, A, “Ideal Aerodynamics of Ground-Effect and Formation Flight

Other Formation Flight Considerations

- Aircraft stability and control, roll trim
- Formation influence on aircraft design
- Formation stability and control
- Pilot-autonomous tradeoff
- Communication
- Formation concepts
 - Homogeneous or heterogeneous aircraft fleet
 - Formation and dispersal
- Finding “best” solutions with so many parameters
 - Formation geometry, number, velocity, altitude, composition
- Operational issues, safety, weather effects,..
- And more.....

Class Charge

The Spring 2004 16.886 class will investigate the possibility of exploiting formation flight for significant new capability for long haul commercial and military cargo. All aspects related to system concepts should be explored including, but not limited to, the number and placement of aircraft in a formation, mix of aircraft size and payload/fuel fractions, aircraft and formation stability and control, degree of autonomy, concepts for formation rendezvous and dispersal, economic, safety, environmental factors, etc.. The size of the class will determine the number of topics that will be explored in depth.

Value Creation Framework

Value - how various stakeholders find particular worth, utility, benefit, or reward in exchange for their respective contributions to the enterprise.

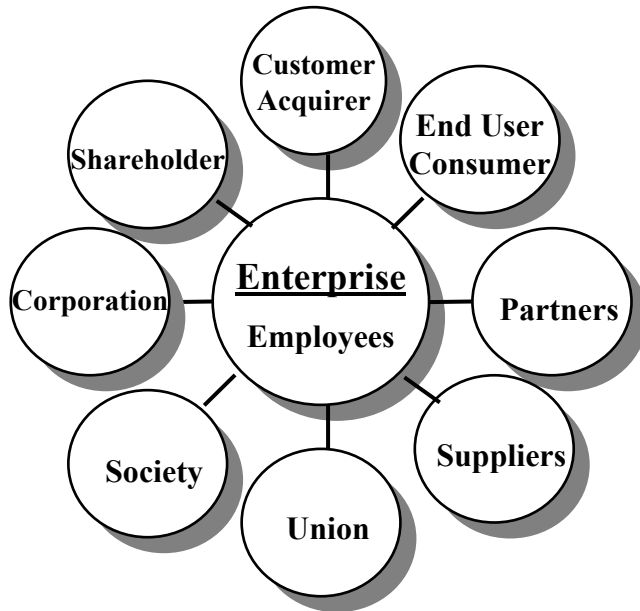

Stakeholders

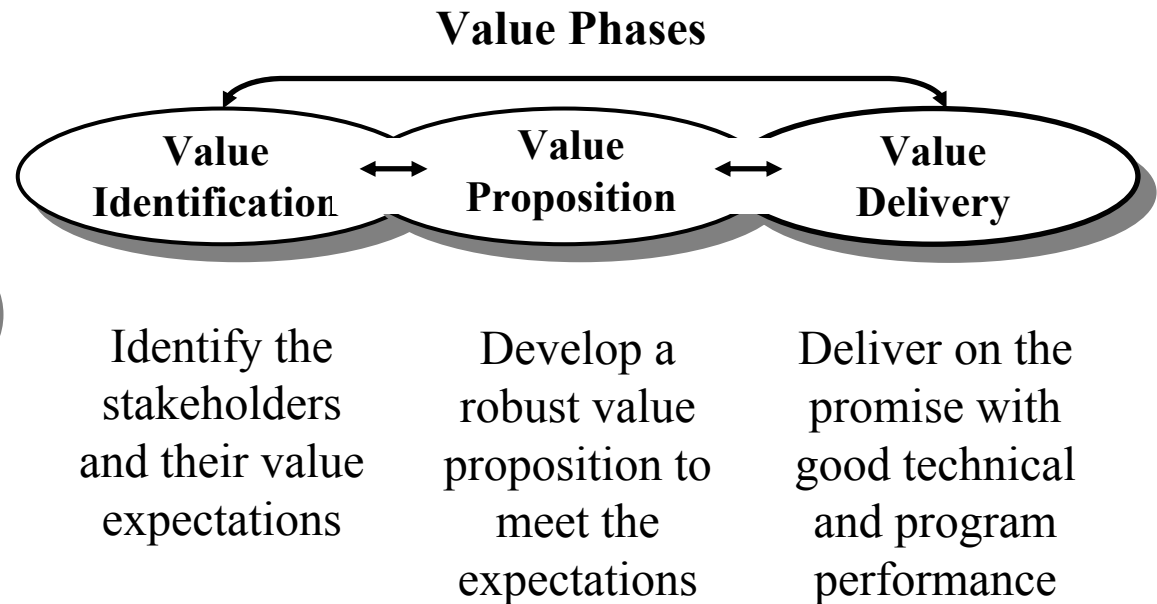

Class Deliverables

The final deliverables for the class will be a written report and accompanying briefing which lays out the feasibility of formation flight for long haul cargo aircraft, candidate system specifications, and gaps in knowledge needed to realize the proposed concept(s). The audiences for these deliverables are decision makers in industry and government, and the engineering community as represented by an AIAA technical conference. The report should include a one page executive summary, a main body of a length and content suitable for a conference paper, and appendices as needed for detailed analysis.

Examples from past classes on course website

Schedule for Semester

Lecture Topics

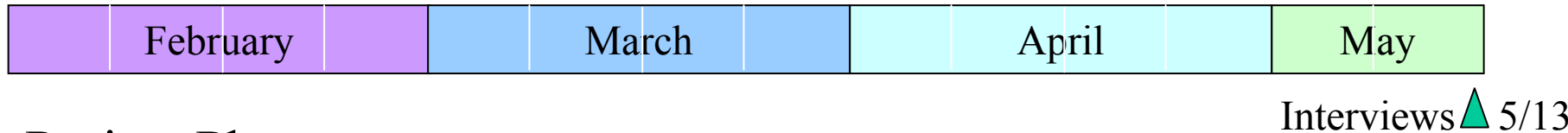
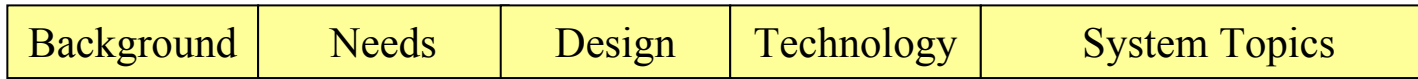

Project Phase

