

8 NONOSCILLATORY TRANSIENTS IN NONLINEAR SYSTEMS

8.0 INTRODUCTION

In general, describing function concepts are directed primarily at the *steady-state* responses of nonlinear systems. The test inputs used to develop most describing functions are therefore based upon signal forms which are expected in steady-state system operation. We have seen this to be the case in the formulation of the sinusoidal-input describing function (DF), two-sinusoid-input describing function (TSIDF), and dual-input describing function (DIDF) of previous chapters. In the latter instance the linearization employed also permitted determination of the *transient* response of a *limit cycling* nonlinear system under certain conditions. When a random process was considered, its statistical properties were determined on a steady-state basis. If, on the other hand, an approximate solution for the *transient* response of a *non-limit-cycling* nonlinear system is desired, we are led to consider *aperiodic* nonlinearity test inputs.

In this chapter we treat two describing functions based on aperiodic test inputs. One is the *transient-input describing function* due to Chen (Refs.

3, 4). It is formulated in a way considerably different from that presented in earlier sections of the text. Second is the *exponential-input describing function*. This new describing function is based on an exponential test input and follows very closely the describing function framework established earlier in the text. Both describing functions, emphasizing simplicity in use, are intended to facilitate the design of nonlinear systems.

8.1 TRANSIENT-INPUT DESCRIBING FUNCTION

The philosophy of quasi-linearization employed here is adopted specifically for the purpose of studying the transient response of nonlinear systems. For convenience, in transient investigation we take the input to be a step. This assumption, however, need not exclude the consideration of another form of input, which may be regarded as generated by the step response of a certain linear network. Nonlinearities under consideration are taken to be piecewise-linear as a result of the approximation procedure to be presented. These are assumed to be followed by linear low-pass elements, as in conventional describing function theory.

At the outset, a problem of circular nature arises. In order to perform an appropriate quasi-linearization of a nonlinear element it is necessary to test that element with a signal which simulates the actual input; however, determination of the actual input depends upon the nonlinearity quasi-linearization, which has allowed the system investigation in the first place. This apparent difficulty may be resolved by recalling that, since the nonlinearity under consideration is piecewise-linear, resulting in a piecewise-linear overall system, the shifting of the nonlinearity operating point during the transient can be readily determined on a "marching" basis. A rough determination of the actual transient response in the first linear range via ordinary linear techniques determines the test function for the nonlinearity in the first two linear ranges. The quasi-linearization so obtained permits a rough evaluation of the actual transient response in the second linear range. This, in turn, determines the test function for the nonlinearity in the first three linear ranges, etc. This procedure is shown to provide useful guidance in design work through yielding a qualitative indication of the dependence of system transient response on system parameters.

The above-outlined quasi-linearization procedure is well illuminated by the following example. Consider the simple system of Fig. 8.1-1, containing a limiter and a pure integrator. Note, first, that this system cannot limit-cycle. Immediately following application of a step input of magnitude R (for $R > \delta$), the limiter output assumes the value D . Accordingly, the actual nonlinearity input is

$$x(t) = R - DKt \quad \text{for } 0 \leq t < \frac{R - \delta}{DK} \quad (8.1-1)$$

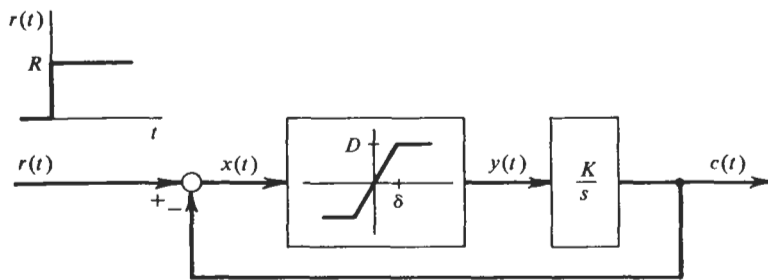

Figure 8.1-1 Simple nonlinear system.

which therefore is used as the test input. Figure 8.1-2 illustrates both nonlinearity input and output signals. At this point the appropriate transient-input describing function can be constructed. This is accomplished by obtaining the nonlinearity output as the summation of a static operation on its input less a *residual* $x_r(t)$, chosen so as to complete the required total output signal description. Figure 8.1-3a shows the resultant dynamic quasi-linear element, of which the static part is the transient-input describing function, $K_{eq} = D/\delta$. As is the case in this example, K_{eq} is generally chosen to be the slope of the nonlinearity at the origin. Figure 8.1-3b illustrates an equivalent block-diagram representation in which $x_r(t)$ is derived by a *linear* operation, $L_r(s)$, on the system input. $L_r(s)$ is derived as follows:

$$\begin{aligned}
 L_r(s) &= \frac{\mathcal{L}[x_r(t)]}{\mathcal{L}[r(t)]} \\
 &= \frac{(R - \delta)D}{\delta s} - \frac{D^2 K}{\delta s^2} \left[1 - \exp\left(-\frac{R - \delta}{DK} s\right) \right] \\
 &= \frac{R}{s} \\
 &= \frac{(R - \delta)D}{R\delta} - \frac{D^2 K}{R\delta s} \left[1 - \exp\left(-\frac{R - \delta}{DK} s\right) \right] \quad (8.1-2)
 \end{aligned}$$

Having formulated the nonlinearity quasi-linearization in terms of the block diagram of Fig. 8.1-3b, the resultant overall linear system can be redrawn as in Fig. 8.1-4a. Consideration of operation reveals that the linear system of Fig. 8.1-4a is a *precise* duplicator of the input-output dynamics of its nonlinear predecessor over the *entire* class of input step functions, because the example nonlinear system response cannot overshoot. The nonlinearity mode of operation (for $R > \delta$) is therefore first in saturation, then always thereafter in the linear range. The transient-input describing function is simply the linear region gain of the nonlinearity, wherewith the residual has

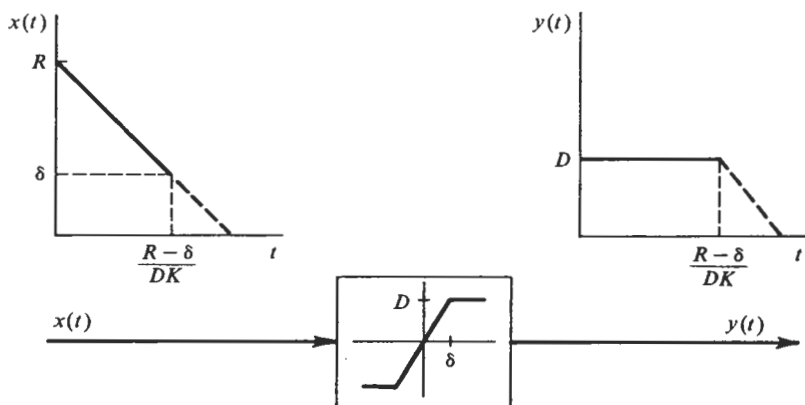
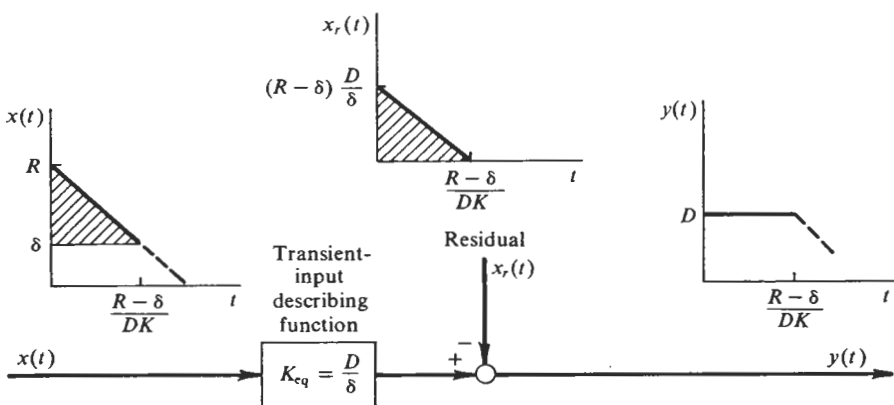

Figure 8.1-2 Testing nonlinearity by actual input. (Chen, Ref. 3.)

been chosen to correct the net linearized nonlinearity output while the nonlinearity is actually in the saturated operating region.

Quasi-linearization of the non-limit-cycling nonlinear system has been accomplished by the use of a transient-input describing function and an appropriate residual $x_r(t)$. In contrast to the describing functions of previous chapters, the transient-input describing function is itself not a function of the input signal; however, the residual in this case may *not* be ignored. *The residual alone accounts for nonlinear operation.* The effect of the nonlinearity is evident in both sections of the quasi-linearized system of Fig. 8.1-4b, which is a somewhat simplified arrangement of Fig. 8.1-4a. Further, since $L_r(s)$ is a function of R , the overall system clearly displays the input-signal dependence characteristic of all nonlinear systems.

Success of the quasi-linearization procedure described depends upon the extent to which the linearized nonlinearity output describes its actual counterpart. To be sure, it is always possible to generate the *exact* nonlinearity output by treating the transient problem in several stages, each one of which is exactly described by a linear constant-coefficient differential equation. This follows from the hypothesized piecewise-linear description of all nonlinearities under consideration. However, the intent here is to generate rapidly an *approximate* nonlinearity output based upon dominant modes and upon the empirical procedures regularly employed in the study of linear systems; and from there to extrapolate the nonlinear-system transient response. Since the value of the proposed quasi-linearization scheme lies primarily in its use in design for specified transient response of nonlinear systems, and since the transient response is commonly specified by approximation concepts derived from the theory of linear systems, it is desirable to examine these concepts.



(a) Defining the transient-input describing function

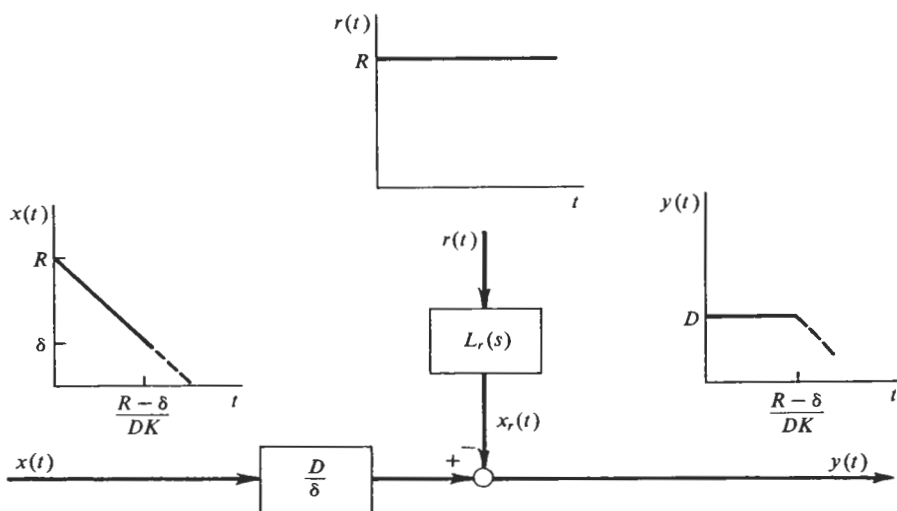

(b) Equivalent block diagram

Figure 8.1-3 Active quasi-linear element. (Adapted from Chen, Ref. 3.)

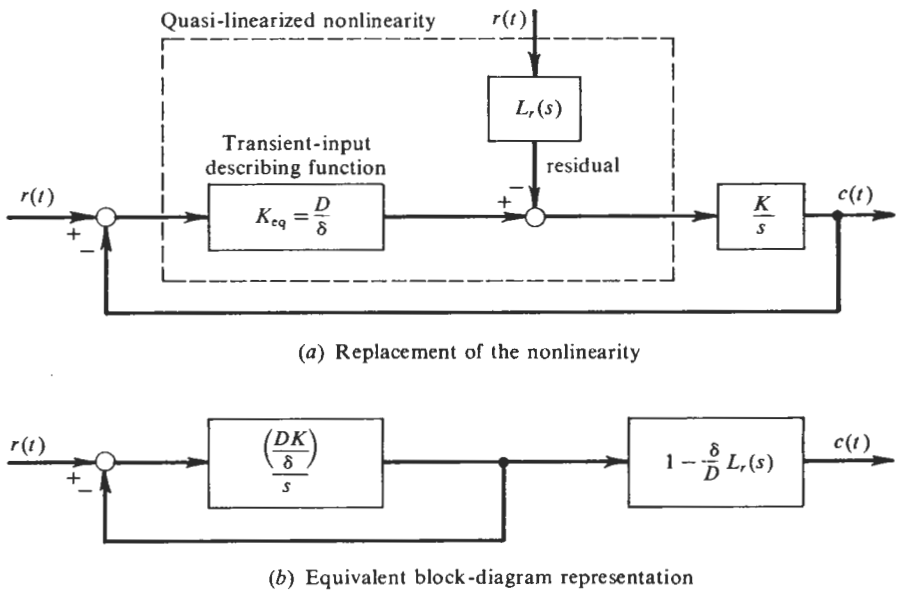

Figure 8.1-4 Quasi-linearized nonlinear system. (Adapted from Chen, Ref. 3.)

8.2 LINEAR-SYSTEM APPROXIMATIONS

Two distinct problem areas in which linear approximation techniques are employed are the derivation of a simplified pole-zero model for the quasi-linearized nonlinear system and determination of the transient response of this model. The former problem relates to the development of a simplified treatment for handling residuals, $x_r(t)$, as discussed below.

DEALING WITH THE RESIDUAL

It is possible to generate the approximate residual required in a given situation by graphical means. Consider, for example, a nonlinear system of the form shown in Fig. 8.1-1, but in which the transfer function of the linear element includes additional denominator dynamics. For transient responses which may overshoot, but in which the peak overshoot does not exceed δ , $x_r(t)$ may be derived from Fig. 8.2-1. At any time $t = t_i$, $x_r(t)$ is simply the difference between the output of a linear element of gain D/δ (the transient-input describing function for this example) and the actual limiter output. This gives the residual as an explicit function of the nonlinearity input x . Provided that x can be obtained as a function of time, $x_r(t)$ directly follows. At this point engineering approximation is essential for ultimate usability of the technique; $c(t)$ must be estimated. Of course, it is always possible to

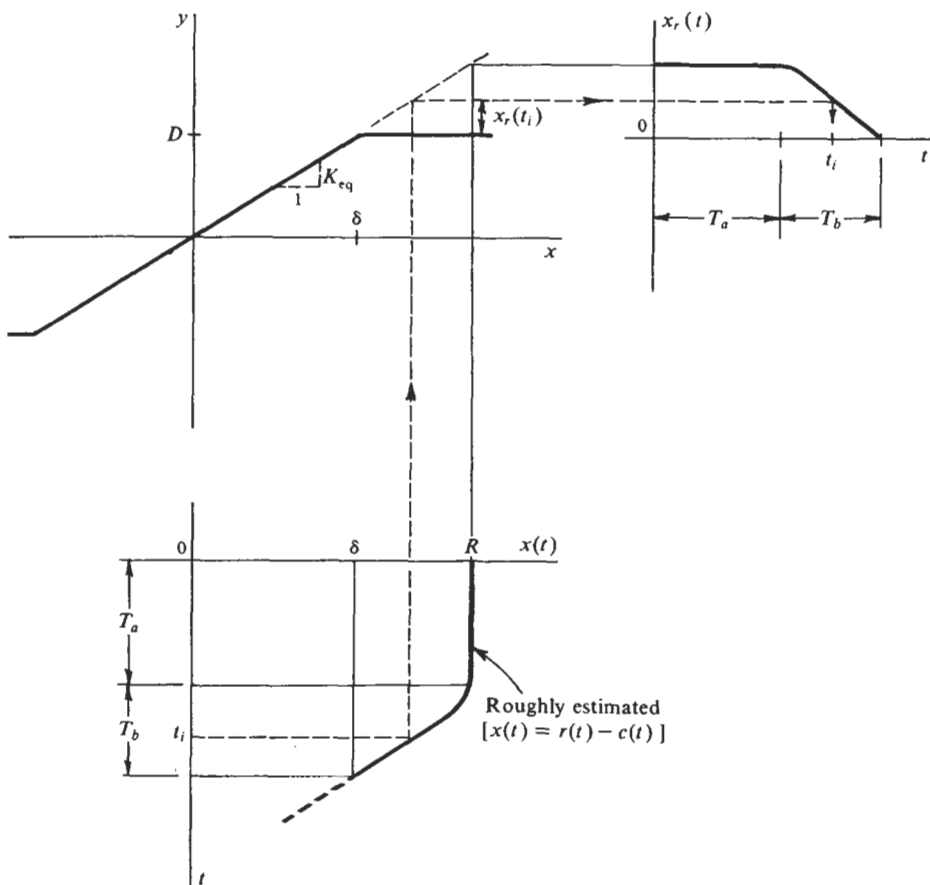

Figure 8.2-1 Example derivation of $x_r(t)$.

compute the required portion of $c(t)$ exactly. With the exception of the simplest cases, however, such a calculation is undesirable. In the hypothetical example under consideration, $c(t)$ often can be described by a dead time, followed by a ramplike function in the initial stages of the transient response. Such is the initial part of the step response of the linear elements. A crude estimate of the dead time serves to calibrate the time axis, which allows determination of $x_r(t)$, as indicated graphically in Fig. 8.2-1. T_a is the estimated output step-response dead time, and $T_a + T_b$ is the estimated time at which the output $c(t)$ reaches the value $R - \delta$. Thus we have derived a trapezoidal residual. It can be further approximated by straight-line segments, as in Fig. 8.2-2. Since this residual shape is of use in a variety of cases, we continue studying it.

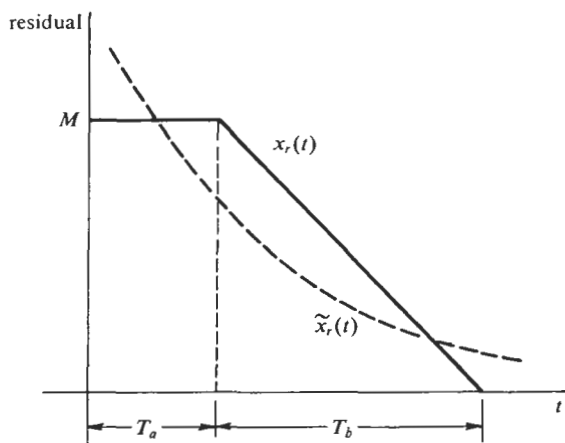

Figure 8.2-2 Approximation of a trapezoidal pulse by a single exponential function. (Chen, Ref. 3.)

The method of quasi-linearization employed defines the residual $x_r(t)$ as the step response of a linear network. Even in the simple example considered in Sec. 8.1, the transfer function of this linear network, $L_r(s)$, is found to be relatively complex. It is of advantage to find a finite nontranscendental linear-network transfer function with which to approximate $L_r(s)$. Such can be found by utilization of the Padé approximation (Ref. 6). The resulting network, denoted by $\tilde{L}_r(s)$, is required to have as its transfer function a ratio of polynomials in s . Its use is based on the assumption of low-pass loop linear elements, a requirement common to all describing function methods.

Returning to the trapezoidal residual of Fig. 8.2-2, the exact transfer function of the linear residual shaping network, $L_r(s)$, is observed to be

$$L_r(s) = \frac{M}{R} - \frac{M}{RT_b s} e^{-T_a s} (1 - e^{-T_b s}) \quad (8.2-1)$$

The approximating network, in general, is taken as

$$\tilde{L}_r(s) = \frac{a_0 + a_1 s + a_2 s^2 + \cdots + a_n s^n}{1 + b_1 s + b_2 s^2 + \cdots + b_n s^n} \quad (8.2-2)$$

$\tilde{L}_r(s)$ can be chosen equivalent to $L_r(s)$ in the Padé sense by expanding each in ascending powers of s and choosing the coefficients a_i and b_i to force equality up to terms of order $2n$ in s . This procedure assures identical output moments, up to order $2n$, in the time domain. In other words,

$$\int_0^\infty x_r(t) t^k dt = \int_0^\infty \tilde{x}_r(t) t^k dt \quad \text{for } 0 \leq k \leq 2n \quad (8.2-3)$$

The expansion of $L_r(s)$ is

$$\begin{aligned} L_r(s) &= \frac{M}{R} - \frac{M}{RT_b s} \sum_{k=0}^{\infty} (-1)^k \frac{T_a^k s^k}{k!} \left[1 - \sum_{l=0}^{\infty} (-1)^l \frac{T_b^l s^l}{l!} \right] \\ &= \frac{M}{R} \left(T_a + \frac{T_b}{2} \right) s - \frac{M}{R} \left(\frac{T_a^2}{2} + \frac{T_a T_b}{2} + \frac{T_b^2}{6} \right) s^2 + \dots \quad (8.2-4) \end{aligned}$$

For simplicity in the final analysis $\tilde{L}_r(s)$ is taken to be of the first order. The required expansion is

$$\begin{aligned} \tilde{L}_r(s) &= \frac{a_0 + a_1 s}{1 + b_1 s} \\ &= a_0 + (a_1 - a_0 b_1) s - b_1 (a_1 - a_0 b_1) s^2 - \dots \quad (8.2-5) \end{aligned}$$

Equations (8.2-4) and (8.2-5), compared, indicate the result that

$$\tilde{L}_r(s) = \frac{(M/R)(T_a + T_b/2)s}{1 + [(3T_a^2 + 3T_a T_b + T_b^2)/(6T_a + 3T_b)]s} \quad (8.2-6)$$

The step response of this network, $\tilde{x}_r(t)$, is sketched in Fig. 8.2-2. To obtain the proper initial value of $\tilde{x}_r(t)$ it is desirable to alter $\tilde{L}_r(s)$ slightly, by so choosing b_1 as to yield

$$\tilde{L}_r(s) = \frac{(M/R)(T_a + T_b/2)s}{1 + (T_a + T_b/2)s} \quad (8.2-7)$$

This function both supplies the correct initial value of $\tilde{x}_r(t)$ and possesses the same output response area (0th moment) as the ideal residual shaping network response of Eq. (8.2-1). The simplicity of this approximating network is evidenced upon application of it in the example system in the following section. Where the initial value of $\tilde{x}_r(t)$ is not of concern, a denominator time constant given by $(3T_a + 2T_b)/6$ yields a useful second approximation which is exact with respect to Eq. (8.2-6) at the extremes $T_a = 0$ or $T_b = 0$.

It is true that higher-order functions $\tilde{L}_r(s)$ can lead to far better approximations to $x_r(t)$. For example, it is possible to find a second-order filter with step response.

$$\tilde{x}_r(t) = Ae^{-\alpha t} \cos(\beta t + \gamma) \quad (8.2-8)$$

which can be fairly closely fitted to $x_r(t)$ of Fig. 8.2-2. Certainly, the approximation is better than that obtained with the residual forming filter of Eq. (8.2-6). The price paid for this refinement is increased computational difficulty.

APPROXIMATIONS FOR LINEAR-SYSTEM TRANSIENT RESPONSE

The final form of the quasi-linearized nonlinear system is a rational linear transfer function, the parameters of which are determined by the original

nonlinear system and the input. All the well-known empirical rules linking transient response with either frequency response or pole-zero data can therefore be brought to bear on the design problem. Conventional measures of transient response, such as *rise time*, *time to peak*, *peak overshoot*, and *settling time*, are extremely useful in this endeavor. Their application is addressed to a system description in terms of *dominant* behavioral modes (e.g., a dominant complex pole pair). Since these are treated at length in standard servo texts, they are not repeated here (see, for example, Refs. 5 and 7).

An important concept in relating the time and frequency or complex domains relates to the regions in each which are dominantly responsible for response characteristics in the other. In particular, it is well known that the low-frequency region (corresponding to poles and zeros near the origin) bears heavily on the final stages of transient response; the high-frequency region (corresponding to poles and zeros far from the origin) bears heavily on the initial stages of transient response; and so on for the intermediate ranges of each. This concept underlies the usefulness of so-called *error coefficients*, which directly relate the response of a linear network to the input and its derivatives or integrals (Ref. 2).

In brief demonstration of the type of approximation to be employed, consider the following quick method of determining *delay time*, suggested by Chen (Ref. 3). A linear transfer function $L(s)$ is assumed describable in the form

$$L(s) = L_1(s) \frac{T_1s + 1}{T_2s + 1} \quad (8.2-9)$$

where the pole and zero at $-1/T_2$ and $-1/T_1$, respectively, are much farther from the origin than any poles and zeros of $L_1(s)$. $L(s)$ may thus be approximated, relative to its contribution to the final portion of the transient (that is, $t \gg 0$ or s small), by

$$L(s) \approx L_1(s)e^{T_1s}e^{-T_2s} \quad (8.2-10)$$

In this form it is clear that the transient response delay time increases with far removed left-half-plane poles and decreases with far removed left-half-plane zeros. Since poles and zeros are not commonly found under the limiting circumstances described, the rule of thumb applicable is to weight the net delay time by a factor of $\frac{1}{2}$. Thus, for the example in question,

$$T_d \approx \frac{1}{2}(T_2 - T_1) \quad (8.2-11)$$

Poles or zeros in the right half-plane may be readily accounted for by utilizing the proper sign in Eq. (8.2-11).

The delay-time concept is by itself most valuable in systems whose initial transient slope is zero or near zero. This slope is quite easily related to the

system poles and zeros. For the general linear network given by

$$L(s) = \frac{\prod_{i=1}^m (T_i s + 1)}{\prod_{j=1}^n (T_j s + 1)} \quad (8.2-12)$$

the slope of the transient response is

$$\frac{dc}{dt}(t) = \mathcal{L}^{-1} \left[R \frac{\prod_{i=1}^m (T_i s + 1)}{\prod_{j=1}^n (T_j s + 1)} \right] \quad (8.2-13)$$

which, at time zero, by the initial-value theorem of Laplace transform analysis, is simply

$$\frac{dc}{dt}(t=0) = \begin{cases} 0 & \text{for } n > m + 1 \\ R \frac{\prod_{i=1}^m (T_i)}{\prod_{j=1}^n (T_j)} & \text{for } n = m + 1 \\ \infty & \text{for } n < m + 1 \end{cases} \quad (8.2-14)$$

The suggested procedure for approximating the residual by a trapezoidal signal followed by the determination of an approximation to the transfer function which yields such a signal from a step input is certainly not the only possible line of approach. Any reasoning which leads to a suitable residual shaping network is admissible. The technique is suggested simply as a standardized procedure useful in a variety of instances.

Armed with a quasi-linear system and the rules of thumb so valuable in linear-system work, the designer may proceed to the main question of nonlinear-system transient response.

8.3 TRANSIENT RESPONSE OF NON-LIMIT-CYCLING NONLINEAR SYSTEMS

Utilizing the transient-input describing function and including the residual in the overall quasi-linear system formulation, we can develop a pole-zero description of the system dynamics. Some of the poles and zeros result as functions of the transient-input amplitude R , correctly indicating that the nonlinear-system response is generally input-amplitude-dependent.

The nonlinear system of Fig. 8.1-1, for example, leads to the quasi-linear

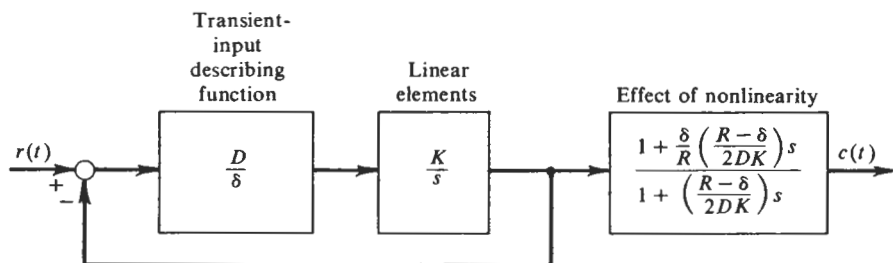

Figure 8.3-1 Quasi-linearized example system. Note that the effect of the nonlinearity appears as an external lag network ($R \geq \delta$).

system of Fig. 8.3-1. The derivation follows from Fig. 8.1-4b, in which $1 - (\delta/D)L_r(s)$ is replaced according to

$$\begin{aligned}
 1 - \frac{\delta}{D} L_r(s) &\approx 1 - \frac{\delta}{D} \tilde{L}_r(s) \\
 &= \frac{1 + \frac{\delta}{R} \left(\frac{R - \delta}{2DK} \right) s}{1 + \left(\frac{R - \delta}{2DK} \right) s} \quad (8.3-1)
 \end{aligned}$$

where $\tilde{L}_r(s)$ is obtained from Eq. (8.2-7) with $T_a = 0$, $T_b = (R - \delta)/DK$, and $M = (R - \delta)(D/\delta)$.

A sequence of pole-zero plots for the example system at the values $R = \delta$, 2δ , 5δ , 9δ is shown in Fig. 8.3-2. The progression of the pole-zero pattern with increasing R (denoted by arrows) clearly indicates the changing transient response character. For $R \leq \delta$ the system dynamics appear independent of R , and are so indicated. As R begins to exceed δ , a pole-zero pair (representing nonlinear operation) moves in toward the origin along the negative real axis. In the limit of increasing R , the system develops a pure integration, and the variable zero asymptotically approaches the value $-2DK/\delta$ or $-2/\tau$.

The initial slope of the approximated transient response for all $R \geq \delta$, as given by Eq. (8.2-14), is

$$\begin{aligned}
 \frac{dc}{dt}(t=0) &= R \frac{\frac{\delta}{R} \left(\frac{R - \delta}{2DK} \right)}{\left(\frac{\delta}{DK} \right) \left(\frac{R - \delta}{2DK} \right)} \\
 &= DK \quad (8.3-2)
 \end{aligned}$$

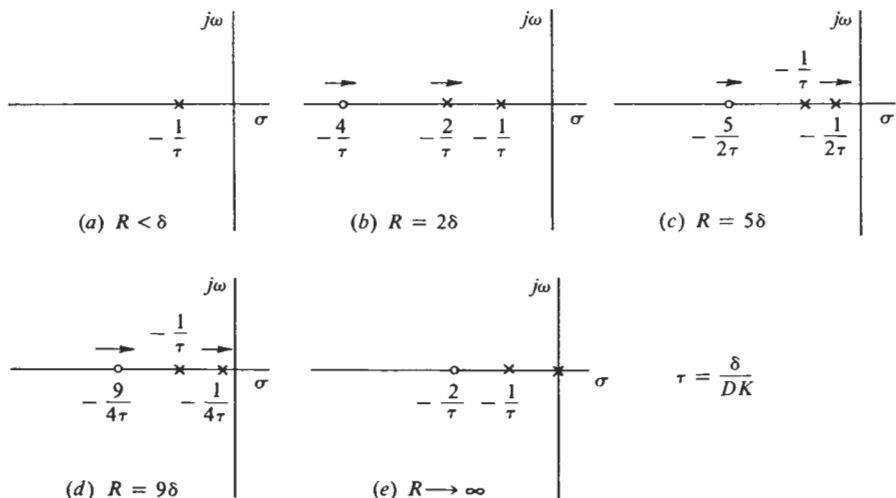

Figure 8.3-2 Pole-zero plots for various input amplitudes, R . (Arrows indicate variable pole and zero migration directions with increasing R .)

This value is exact. The transient response settling time (time to within 95 to 105 percent of final value) is approximately given by three dominant system time constants. For $R \geq 5\delta$ it takes the value

$$T_s \approx \frac{3(R - \delta)}{2DK} = \frac{3}{2} \left(\frac{R}{\delta} - 1 \right) \tau \quad (8.3-3)$$

Use of this type of approximation enables sketching the transient response of the quasi-linear system.

For the simple system of Fig. 8.3-1, the transient response is readily determined by linear theory as

$$\frac{1}{\delta} c(t) = \frac{R}{\delta} - \frac{(R - \delta)^2}{\delta(R - 3\delta)} \exp\left(-\frac{2DK}{R - \delta} t\right) + \frac{R + \delta}{R - 3\delta} \exp\left(-\frac{DK}{\delta} t\right) \quad (8.3-4)$$

This function is plotted in Fig. 8.3-3 for $R = \delta, 2\delta, 5\delta, 9\delta$, together with the exact transient responses of the original nonlinear system, given by

$$\frac{1}{\delta} c(t) = \begin{cases} \frac{DK}{\delta} t & 0 \leq t < \frac{R - \delta}{DK} \\ \frac{R}{\delta} \left[1 - \frac{\delta}{R} \exp\left(\frac{R - \delta}{\delta}\right) \exp\left(-\frac{DK}{\delta} t\right) \right] & t > \frac{R - \delta}{DK} \end{cases} \quad (8.3-5)$$

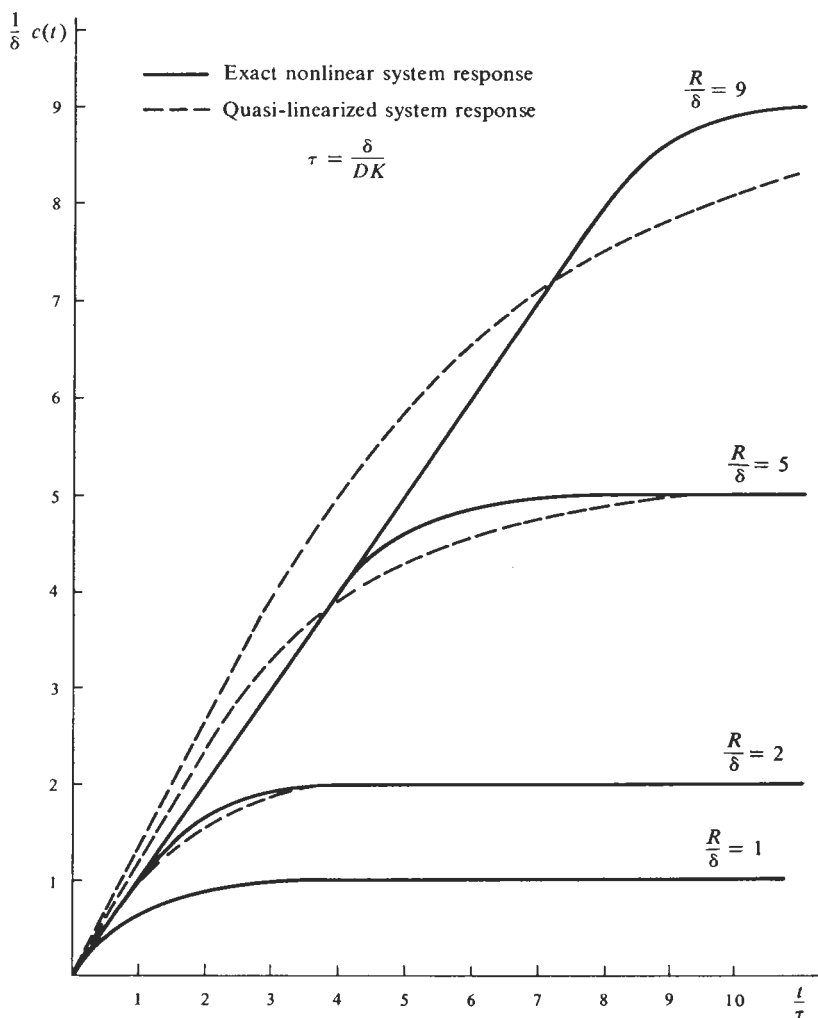

Figure 8.3-3 Exact and quasi-linear example-system responses.

At $R/\delta = 1$, of course, the exact and quasi-linearized responses coincide. With increasing R/δ , the difference between exact and approximated responses increases because of the limitations existing in any two-exponential fit to a straight line, the now dominant portion of the actual nonlinear-system response. In fact, in view of this difficulty, one must conclude that the simple linear-system approximation to the actual nonlinear-system response is rather good. All major aspects of the transient response are indeed accounted for in quasi-linearization. More important, the system poles

and zeros, and hence the transient response descriptors, are given in terms of system parameters.

The simple system used as the vehicle with which to convey the concept of quasi-linearization for transient response could well have been studied more exhaustively, and in fact with greater ease, by the phase-plane approach mentioned in Chap. 1. A third-order linear part to the example system would, however, require recourse to phase-space techniques; a fourth-order linear part could not be studied at all without substantial approximations reducing the order of the system. The transient-input describing function method, on the other hand, is not limited by the order of the system.

8.4 DESIGN PROCEDURE FOR A SPECIFIED TRANSIENT RESPONSE

The limiting factor in general utilization of the method described above relates to the difficulty in determining the residual, $x_r(t)$, and hence in obtaining a satisfactory residual shaping network $\tilde{L}_r(s)$ with which to account adequately for nonlinear behavior. Again it is pointed out that the nonlinear-system response solution can always be obtained by the piecewise-linear point of view, giving $x(t)$ analytically and exactly. From this comes the required $x_r(t)$; whence it follows that $L_r(s)$ can be exactly determined. Unfortunately, $L_r(s)$ generally results as a very complicated transcendental function. The use of a simplified nontranscendental residual shaping network $\tilde{L}_r(s)$, of no higher than second order, is mandatory for the eventual pencil-and-paper application of this method. The approximations which, in practice, must be made in the determination of $\tilde{L}_r(s)$ represent the most critical calculations incurred. Given that these can be executed according to reasonable engineering judgment, the resulting quasi-linear systems provide a useful analytical means for describing nonlinear-system transient behavior.

Chen (Ref. 4) suggests a very interesting technique which mitigates the above problem in design. Figure 8.4-1a illustrates the class of nonlinear systems to which this design procedure is applicable. Based on the given system specifications, one first seeks for a suitable hypothetical *totally linear system* and interprets this linear system in terms of a unity feedback configuration. Now, if the actual nonlinear system is to behave like the hypothetical linear system, the error signals in each instance must be quite similar. Hence the error signal derived from the linear system is used to test the nonlinearity, and thereby determine a suitable $x_r(t)$. This procedure is diagrammed in Fig. 8.4-2.

Once $x_r(t)$ is obtained, the procedure outlined in Sec. 8.2 is followed to give a suitable residual-forming network $\tilde{L}_r(s)$. Manipulating the now linear system block diagram as in Fig. 8.1-4 enables the residual-forming filter to be

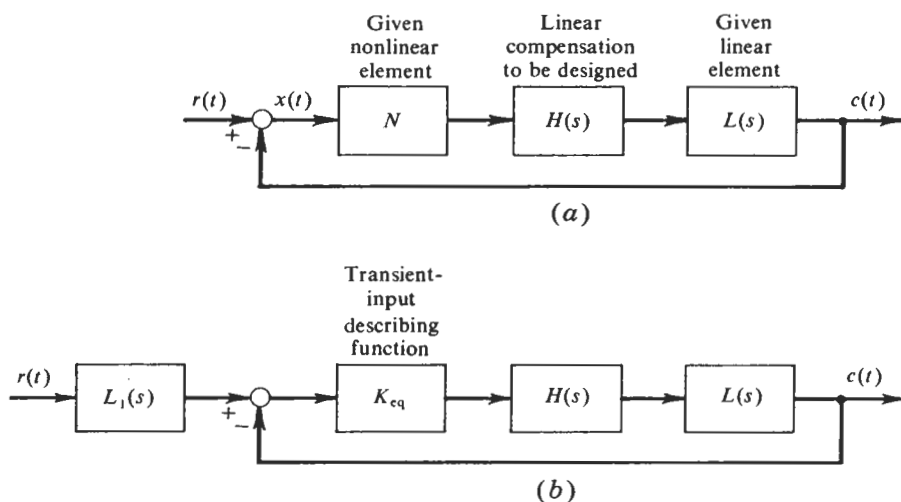

Figure 8.4-1 (a) Allowable control-system configuration. (b) Configuration of the quasi-linearized system. (Adapted from Chen, Ref. 4.)

transferred to a series connection with the closed loop. This defines $L_1(s)$ in Fig. 8.4-1b. The compensation network $H(s)$ is now chosen by purely linear design techniques to enable the quasi-linearized system to meet overall specifications.

At this point the compensated nonlinear system is simulated on an analog computer, and the response obtained. If the response does not meet specifications, either the transient-input describing function representation

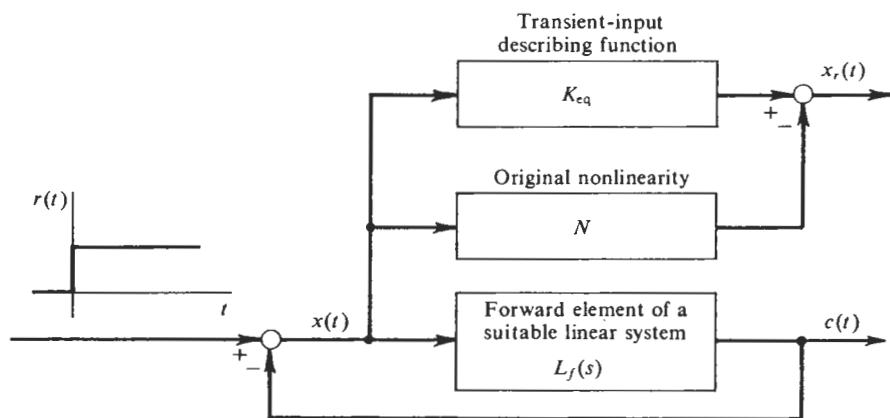

Figure 8.4-2 Computer setup for approximate determination of the residual. (Adapted from Chen, Ref. 4.)

can be changed slightly and the process repeated, or $H(s)$ can be refined. Regarding this procedure the reader should note that the analog computer has been applied in a systematic way. Intuition has not been heavily relied on, and a gross parameter-search procedure has been avoided.

8.5 EXPONENTIAL-INPUT DESCRIBING FUNCTION (EIDF)

In this section we present a new and quite useful technique of approximate solution for the transient response of nonlinear systems. The basis for this new approach, the *exponential-input describing function*, closely follows the main theme of this book. Thus, the ensuing presentation is brief and to the point. A related viewpoint can be found elsewhere (Ref. 1).

Consider the nonlinear system of Fig. 8.5-1a. If the output increases monotonically to its steady-state value when excited by a step input, the

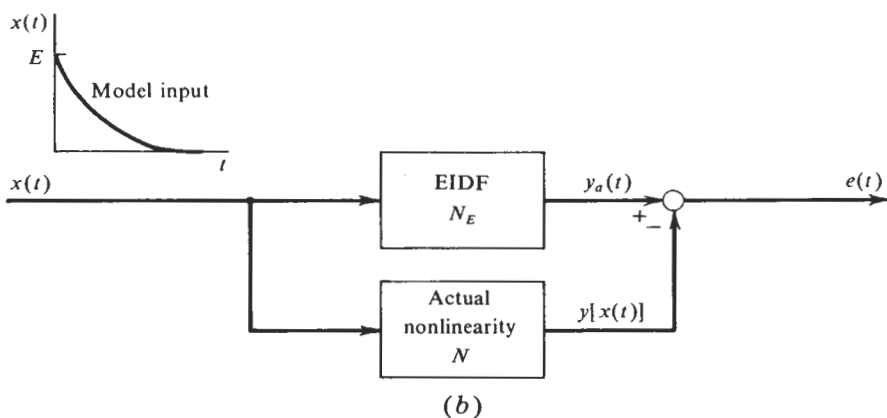
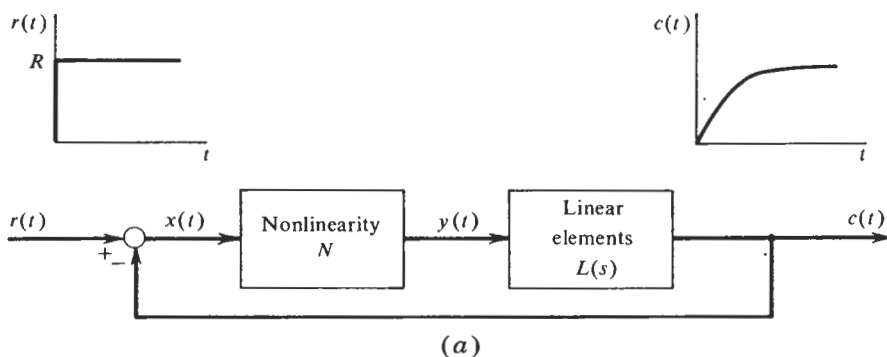

Figure 8.5-1 (a) Nonlinear system with nonoscillatory transient response. (b) Corresponding EIDF formulation.

signal $x(t)$ will correspondingly decrease in a monotonic way. Thus, we are led to consider a *model* input which is an *exponential*. The EIDF representation of the nonlinearity is arrived at by minimizing the integral-squared error in a linear approximation to the actual nonlinearity output; see Fig. 8.5-1b. The representation error, e , is

$$e(t) = N_E x(t) - y[x(t)] \quad (8.5-1)$$

where N_E is a fixed linear gain. The corresponding squared error, integrated over all time, is

$$\int_0^{\infty} e^2(t) dt = N_E^2 \int_0^{\infty} x^2(t) dt - 2N_E \int_0^{\infty} x(t)y[x(t)] dt + \int_0^{\infty} y^2[x(t)] dt \quad (8.5-2)$$

Minimizing this expression by differentiating with respect to N_E and setting the result to zero yields the EIDF,

$$N_E = \frac{\int_0^{\infty} x(t)y[x(t)] dt}{\int_0^{\infty} x^2(t) dt} \quad \text{for } x(t) = Ee^{-t/\tau} \quad (8.5-3)$$

Calculation of the EIDF proceeds easily. In the case of the sharp saturation (limiter) nonlinearity, for example, we get ($E > \delta$)

$$\begin{aligned} N_E(E) &= \frac{\int_0^{t_1} Ee^{-t/\tau} D dt + \int_{t_1}^{\infty} Ee^{-t/\tau} \frac{D}{\delta} Ee^{-t/\tau} dt}{\int_0^{\infty} E^2 e^{-2t/\tau} dt} \\ &= \frac{-ED\tau(e^{-t_1/\tau} - 1) + \frac{E^2 D}{\delta} \left(\frac{\tau}{2}\right) e^{-2t_1/\tau}}{\frac{\tau E^2}{2}} \end{aligned}$$

Noting that

$$e^{-t_1/\tau} = \frac{\delta}{E}$$

we obtain

$$N_E(E) = \frac{2D}{E} \left(1 - \frac{\delta}{2E}\right) \quad E > \delta \quad (8.5-4)$$

EIDFs for other common nonlinearities are presented in Fig. 8.5-2. Note that in the case of *all* static nonlinearities, the EIDF is *independent* of τ . This fact greatly facilitates its use, as we see in the following examples.

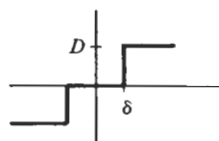

$$N_E = 0 \quad |E| \leq 0$$

$$= \frac{2D}{|E|} \left(1 - \frac{\delta}{|E|}\right) \quad |E| > \delta$$

(a) Relay with dead zone

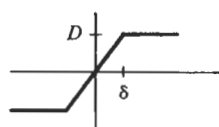

$$N_E = \frac{D}{\delta} \quad |E| \leq \delta$$

$$= \frac{2D}{|E|} \left(1 - \frac{\delta}{2|E|}\right)^2 \quad |E| > \delta$$

(b) Sharp saturation

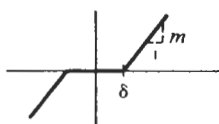

$$N_E = 0 \quad |E| \leq \delta$$

$$= m \left(1 - \frac{\delta}{|E|}\right)^2 \quad |E| > \delta$$

(c) Deadband gain

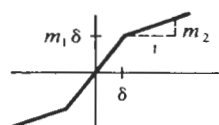

$$N_E = m_1 \quad |E| \leq \delta$$

$$= \frac{2\delta}{|E|} (m_1 - m_2) \left(1 - \frac{\delta}{2|E|}\right) + m_2 \quad |E| > \delta$$

(d) Gain-changing element

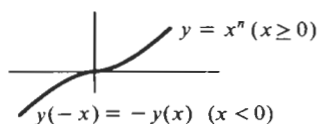

$$N_E = \frac{2}{n+1} |E|^{n-1}$$

(e) Polynomial nonlinearity

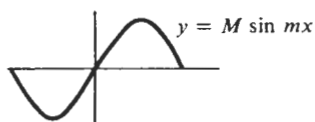

$$N_E = \frac{2M}{mE^2} (1 - \cos mE)$$

(f) Harmonic nonlinearity

Figure 8.5-2 Exponential-input describing functions for some common nonlinearities.

Example 8.5-1 Solve for the transient response of the system illustrated in Fig. 8.1-1 by the exponential-input describing function method.

The first step is to replace the limiter by its exponential-input describing function,

$$N_E = \frac{2D}{|E|} \left(1 - \frac{\delta}{2|E|} \right)$$

Next, for the resulting linearized system, we write

$$C(s) = \frac{1}{\frac{s}{\frac{2DK}{R} \left(1 - \frac{\delta}{2R} \right)} + 1} \frac{R}{s}$$

where E , the peak exponential-input model amplitude, has been set equal to R . Inverse transforming to obtain $c(t)$ yields

$$c(t) = R \left\{ 1 - \exp \left[- \frac{2DK}{R} \left(1 - \frac{\delta}{2R} \right) t \right] \right\}$$

This solution, simpler than that of Eq. (8.3-4), is almost as good an approximation to the exact system response.

Example 8.5-2 Use the exponential-input describing function to compute the approximate transient response of the system illustrated in Fig. 4.1-2 when subject to the initial conditions $c(t=0) = c(0)$ and $\dot{c}(t=0) = 0$.

The exponential-input describing function for the ideal relay can be obtained by setting δ to zero in the corresponding expression for the relay with dead zone, Fig. 8.5-2. The result is

$$N_E = \frac{2D}{|E|} = \frac{2D}{c(0)}$$

where we have identified E , the peak value of the exponential-input model, as being equal to $-c(0)$. Replacing the ideal relay nonlinearity with the exponential-input describing function and treating the resulting linearized system by familiar transform techniques yields

$$C(s) = \frac{s + b}{s^2 + bs + KN_E} c(0)$$

Dividing the numerator and denominator of the right-hand side of this equation by b^2 and employing the normalized variables

$$p = \frac{s}{b} \quad \text{and} \quad V = \frac{DK}{b^2}$$

results in

$$C(p) = \frac{p + 1}{p^2 + p + 2V/c(0)} \frac{c(0)}{b}$$

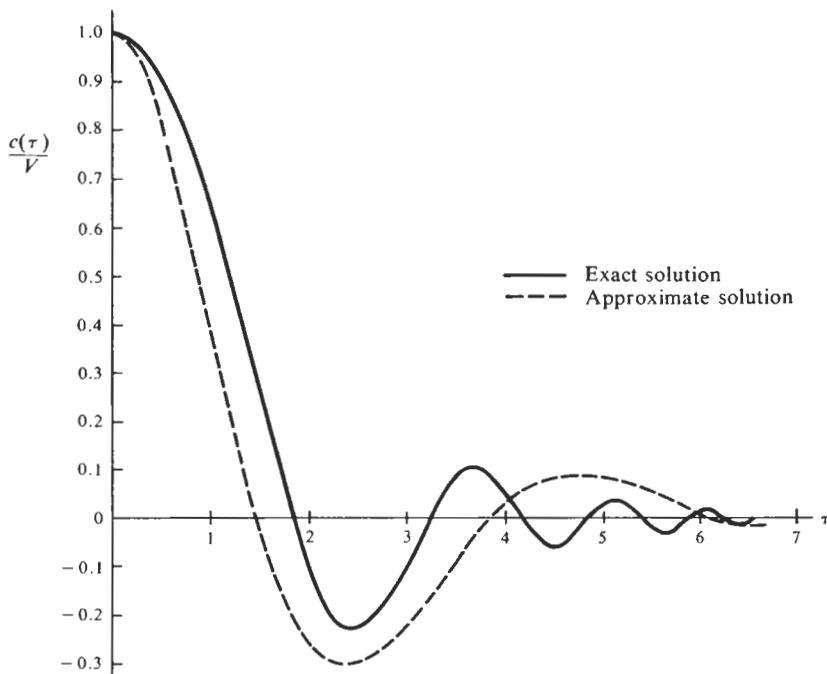

Figure 8.5-3 Solution of Example 8.5-2.

For the specific case in which $c(0) = V$ this becomes

$$C(p) = \frac{p+1}{p^2+p+2} \frac{V}{b}$$

which, upon inversion [keeping in mind the fact that $\mathcal{L}^{-1}\left[C\left(\frac{s}{b}\right)\right] = bc(bt)$], yields

$$c(\tau) = Ve^{-\tau/2} \left(\cos \frac{\sqrt{7}}{2} \tau + \frac{1}{\sqrt{7}} \sin \frac{\sqrt{7}}{2} \tau \right)$$

where $\tau = bt$. This result is plotted in Fig. 8.5-3, along with the exact system response.

The approximate transient response curve is seen to be quite good, considering the degree of ease with which it was obtained. The nature of the response as well as its approximate settling time are reasonably well determined. It must be kept in mind that the oscillatory $c(\tau)$ is the actual nonlinearity input, whereas an exponential was originally assumed for the purpose of quasi-linearization!

Certainly, the EIDF is an extremely simple device to use. For this reason it has significant use as a nonlinear-system design tool in the area of transient response, where only little of design value can be said by other means. On the other hand, it can be expected only to provide *gross* transient response characteristics.

From the way in which it has been formulated, it can be seen that the EIDF quasi-linearized system will always have the dynamics associated with a closed-loop system composed of the original linear elements and an input-sensitive gain factor. Thus, certain transient effects can *not* be observed. This was seen in Example 8.5-2, where the exact solution had a time-variable oscillation frequency. The techniques of Chap. 4 are required to ascertain that level of detail in the transient response. But, if a system designer wanted quick insight into the behavior of this system, the EIDF transient solution coupled with the DF steady-state limit cycle solution [zero (small) amplitude at infinite (high) frequency] surely do provide the required information. System compensation could then be designed on an analytic basis, to be checked by subsequent computer simulation.

REFERENCES

1. Bickart, T. A.: The Exponential Describing Function in the Analysis of Nonlinear Systems, *IEEE Trans. Autom. Control*, vol. AC-11, no. 3 (July, 1966), pp. 491-497.
2. Biernson, G.: A Simple Method for Calculating the Time Response of a System to an Arbitrary Input, *M.I.T. Servomech. Lab. Rept. 7138-R-3*, January, 1954.
3. Chen, K.: Quasi-linearization Techniques for Transient Study of Nonlinear Feedback Control Systems, *AIEE Trans.*, pt. II, *Appl. Ind.*, January, 1956, pp. 354-365.
4. Chen, K.: Quasi-linearization Design of Nonlinear Control Systems, *Proc. JACC*, Minneapolis, Minn., June, 1963, pp. 340-346.
5. Grabbe, E. M., S. Ramo and D. E. Wooldridge: "Handbook of Automation, Computation and Control," John Wiley & Sons, Inc., New York, 1958, chap. 22.
6. Stewart, J. L.: Generalized Padé Approximation, *Proc. IRE*, vol. 48, no. 12 (December, 1960), pp. 2003-2008.
7. Truxal, J. G.: "Automatic Feedback Control System Synthesis," McGraw-Hill Book Company, New York, 1955, chap. 5.

PROBLEMS

- 8-1. Show that for the nonlinear system of Fig. 8-1 the quasi-linearized transient response is

$$c(t) = (R - \delta) \left[1 - \exp \left(- \frac{DK}{R - \delta} t \right) \right]$$

and compare this with the exact transient response.

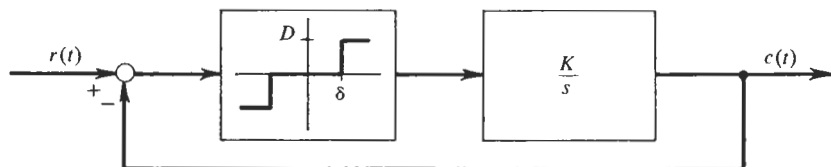

Figure 8-1 Nonlinear relay system.

8-2. Repeat Prob. 8-1 but with the transfer function $K/s(Ts + 1)$ rather than K/s . *Hint:*

$$\text{Determine by expanding an exponential, that } T_A^2 \approx \frac{[2T(R - \delta)]}{DK}.$$

8-3. The input-output specification for the nonlinear system of Fig. 8-2 is given in the form of a desired second-order response, with $\zeta = 0.7$ and $\omega_n = 1$. Design a compensation network $H(s)$ to achieve this response. [*Hint:* Approximate $x(t)$ by straight-line segments.]

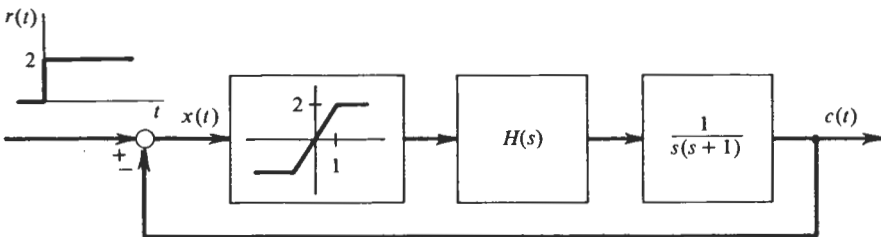

Figure 8-2 Example system for transient response compensation.

8-4. (a) Show that the EIDF technique is not restricted to systems with unity gain feedback links. What configuration restrictions do apply?

(b) Discuss the "filter hypothesis" as it relates to accuracy of the EIDF method.

(c) Consider the use of a more accurate EIDF model input given by $Ee^{-(t-T_d)^{1/r}}$ where T_d is the delay time of the loop linear elements. In what way does T_d affect calculation of the EIDF? How would you employ this formulation?

(d) Investigate the utility of a more complex model input than that presented in the text, namely, $Ee^{-t/r} \cos(\omega t + \alpha)$. Does this lead to a tractable EIDF calculation?

(e) What avenues of approach can you suggest for EIDF method accuracy enhancement?

8-5. Solve Probs. 8-1 to 8-3 using the EIDF method. What can be said about system output stand-off errors in the case of nonlinearities with dead zone?

8-6. Compute the EIDF for the dynamic nonlinearity given by

$$y(\dot{x}, x) = -x\dot{x}$$

How would you use this result in solving for the transient response of a system with linear elements $L(s) = K/[s(s + 1)]$?